



CONVEYOR SELECTION GUIDE

AUTOMATION SERIES

HYDROCLEAN SERIES

INDUSTRIAL SERIES

# CONVEYOR SELECTION GUIDE

# AS40: Belt Conveyor

- » Rigid, single-piece aluminum frame\*
- » Built-in tee slots allow rapid accessory mounting
- » Supports optional V-Guide Belts for reversing and side-loading applications
- » High speed rolling Nosebar Tails available for tight transfers
- » Available AC or Brushless DC Motors offer compact drives capable of high speeds

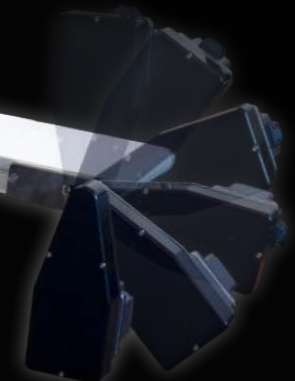

» Unique **Pivot™ Drive** package rotates to any position for maximum flexibility

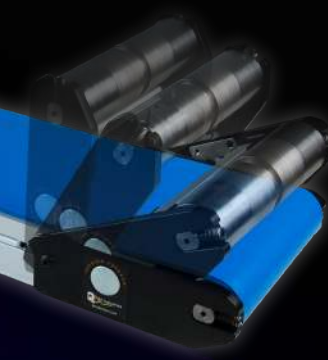

» Push-button **Tension Release Tail** allows fast belt changes and easy access to frame to clean or clear debris

## Specifications

- » Widths: 2" to 24"
- » Lengths: up to 20'
- » Loads: up to 120 lbs
- » Speeds: up to 400 FPM
- » Profile: 1.95" High
- » Assembled with all Metric Fasteners

\* Conveyors 12" and wider feature multi-piece steel/aluminum construction

# AS40-CD: Center Drive

- » Center Drive can be positioned at any point along the length of the conveyor — simply loosen a few screws, slide to new location and re-tighten
- » Large sealed, double-row ball bearings support high speeds up to 400 FPM



## Specifications

- » Widths: 2" to 24"
- » Lengths: up to 26'
- » Loads: up to 120 lbs
- » Speeds: up to 400 FPM
- » Profile: 1.95" High
- » Assembled with all Metric Fasteners



# AS40-Z: Angled Frame

- » Rigid aluminum frame with tee slots
- » V-Guide Belts ensure proper tracking in any application
- » Tension Release Tail flips up at the push of a button for fast belt change and easy access to frame to clean or clear debris
- » Sealed, double-row ball bearings for higher loads and longer life
- » Z-Track design gives you greater control over belt tracking and longer belt life

## Specifications

- » Widths: 8" to 24"
- » Lengths: up to 20'
- » Profile: 1.95" high
- » Load: up to 120 lbs
- » Speeds: up to 200 FPM
- » Angles: 30°, 45°, 60°

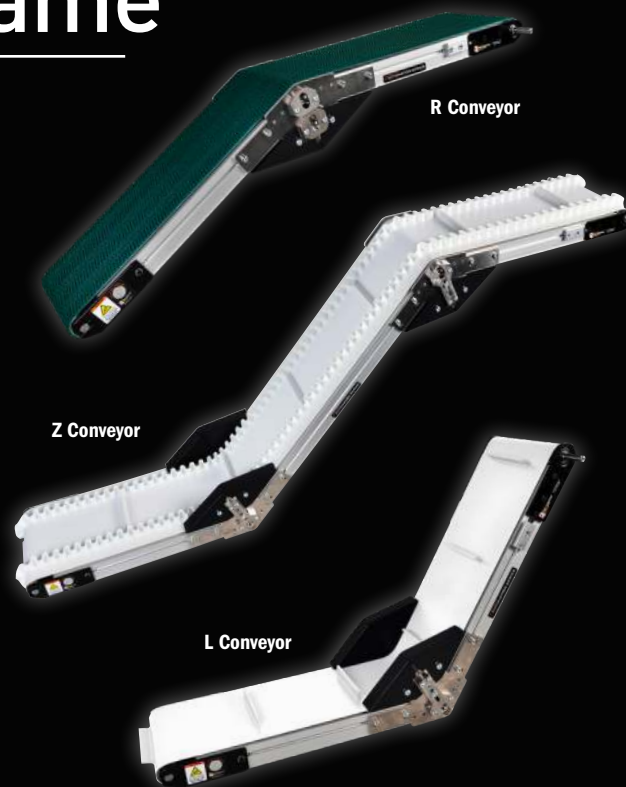

# HC200: Sanitary Conveyors

- » **Stainless steel**, sanitary design which is easy to clean
- » **Sides, guides, belt, drive end and tail end** can be removed for cleaning without tools
- » Slider bed is **self draining** and fasteners are designed to minimize opportunities for bacteria growth
- » **Extremely quiet operation** is ideal for applications where workers are nearby
- » **NSF Certified & BISSC Certified** with **FDA** and **USDA** suitable antimicrobial belting available
- » **Stainless steel bearings** with **NSF approved MicroPoly™** solid lubricant are sealed for life and covered for extra protection
- » **Drive and tail pulleys** are v-guided and crowned to ensure proper tracking
- » **Plastic Chain** belting available



## Specifications

- » Widths: 4" to 24"
- » Lengths: 42" to 18'
- » Load Capacity: 120 lbs
- » All stainless steel construction
- » Metric hex head and slotted bolts used throughout assembly



# Fast, Efficient Cleaning

HC200 Conveyors feature a sanitary design for handling all types of applications including food products, pharmaceutical, medical devices, clean rooms and more. They offer a variety of options designed to fit your unique application.

The tail flips up to relieve tension on the belt simply by removing two pins, making it fast and easy to remove the belt or clean product spills from underneath.

Tool-less belt, tail and drive removal allow for in-depth cleaning. Watch the video at [qcconveyors.com/HC200video](http://qcconveyors.com/HC200video) to see it in action.



Pull pins make it easy to disassemble the conveyor quickly for in-depth cleaning

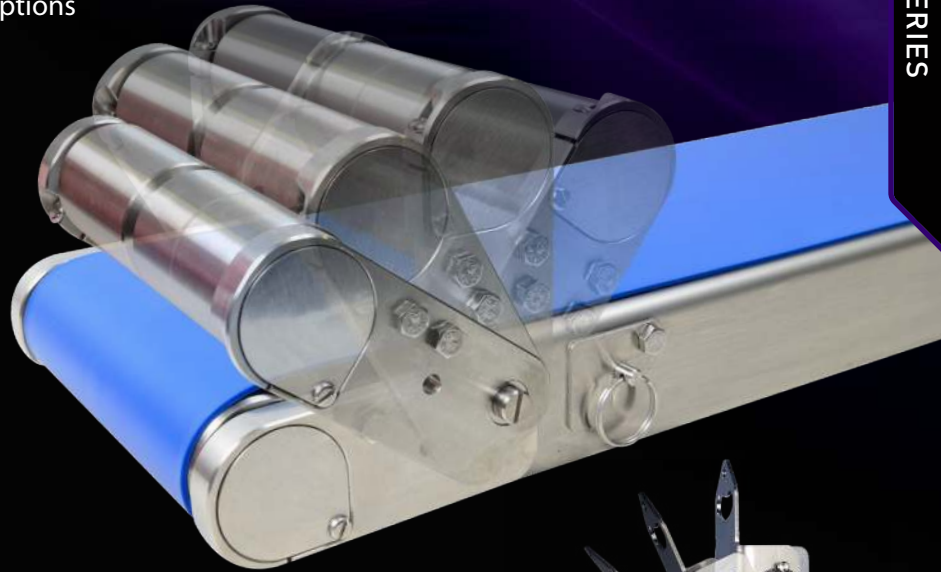

» Stand brackets flip out of the way for easy belt removal

## Tool-less drive removal



## Tool-less tail removal



# IS125: Belt Conveyor

- » Tough, single piece steel frame supports heavy loads up to 450 lbs
- » Very low profile (1.89") – fits where conventional conveyors can't
- » Lube-for-Life Bearings™ eliminate routine bearing maintenance
- » Unique snap-in sealed tail assembly – makes belt replacement quick and easy



## Specifications

- » Widths: 2" to 24"
- » Lengths (Standard): 18" to 12'
- » Lengths (Extended): 13' to 23'
- » Profile: 1.89" high
- » Load: up to 450 lbs
- » Speed: up to 225 FPM



## Cleated

- » Cleated conveyors offer **positive part movement** for lightweight parts and incline/decline applications
- » Cleats are **high frequency welded**, not glued, increasing the strength of the bond between belt and cleat
- » Cleats are available in **5 heights**: 5mm, ½ in, 1 in, 2 in, 3 in

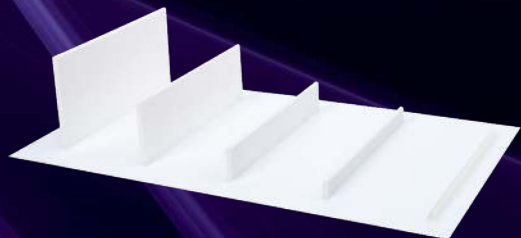

# IS125-FT: Plastic Chain

- » **Low profile** – Drive end 3.03" height, frame only 2.41"
- » **More than 100 belt styles** to fit any application
- » **High speeds** to 375 FPM and heavy loads up to 500 lbs
- » **Lube-for-Life Bearings** for **maintenance-free operation**



## Flush Grid Belts

General purpose belt; low coefficient of friction for accumulation applications; economical

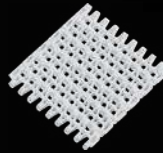

## Flat Top Belts

Open hinge design for easy cleaning

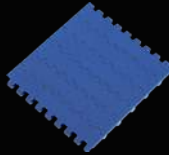

## Belts with Flights & Sideguards

Ideal for incline applications; sideguards keep product contained



## Specifications

- » Widths: 4" to 24"
- » Lengths: 2' to 40'
- » Profile: 3.03" high
- » Belt Pitch: 1"

# IS175-ID: Embedded Drive Conveyor

- » **Quiet, efficient 24vdc motor** located inside the drive pulley – all within a low 2.54" profile
- » **Maintenance-free** – no bearings or gearboxes to lubricate
- » **Safe** – Low-voltage protects workers from dangerous currents
- » **Variable-speed control card** easily integrates with automation systems for "run on demand" applications, using inhibit/run controls from devices such as timers and photo-eyes

## Specifications

- » Widths: 12", 18", 24"
- » Lengths: 18" to 144"
- » Profile: 2.54" high
- » Load: up to 75 lbs
- » Speeds: Incrementally variable; 7-47 FPM

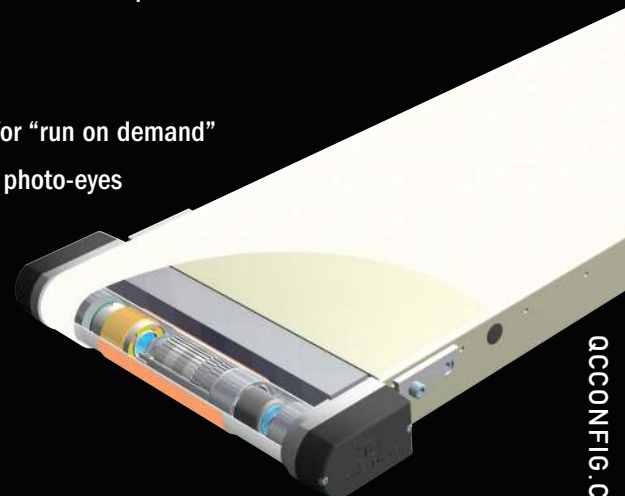

# IS300: Indexing Conveyor

INDUSTRIAL  
SERIES

- » Precision indexing accurate to  $\pm .015$ "
- » Positive, non-slip timing pulley and self-aligning sealed drive bearings
- » Cleats can be custom-molded to fit your application

## Specifications

- » Widths: up to 18"
- » Lengths: up to 24'
- » Profile: 3" high
- » Belt: 10mm pitch teeth
- » Speeds: Up to 2,000 FPM

Convertible timing belt cleats are easily attached or removed to meet changing application requirements

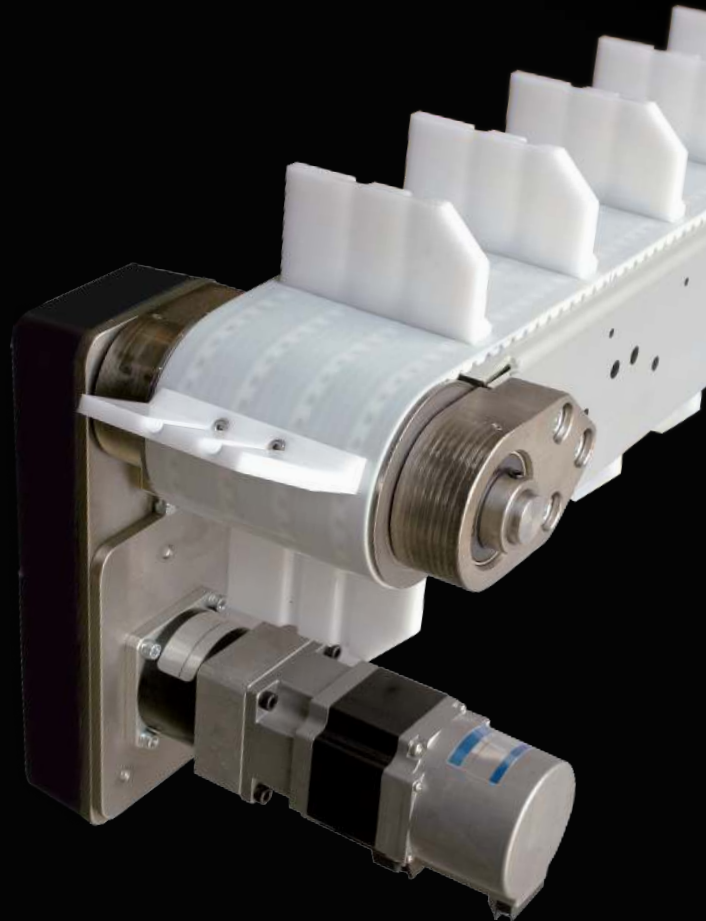
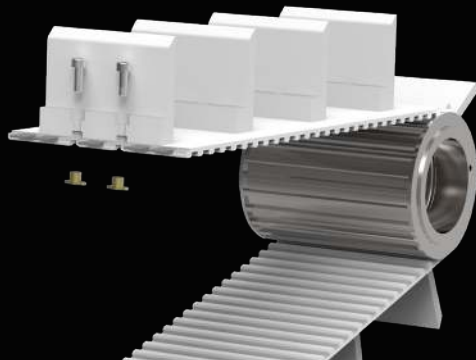

# IS400: Heavy Duty Conveyor

INDUSTRIAL  
SERIES

- » Heavy-duty load carrying capacities up to 600 lbs
- » High speeds — up to 360 FPM
- » V-Guide option for side-loading or reversing applications

## Specifications

- » Widths: 6" to 48"
- » Lengths: up to 36'
- » Profile: 3" high

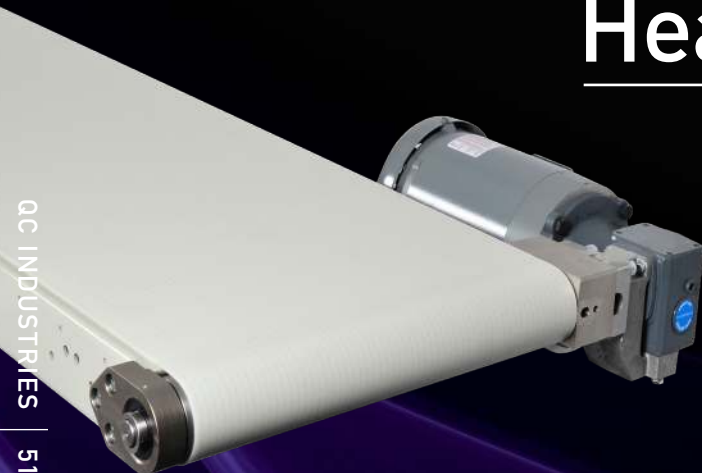



# Custom Conveyor Solutions

If you're looking for something a little different than our standard conveyors, we can customize it for you. Whether it's a bracket to integrate with a customized piece of equipment, a drive mount for your motor, or a modification to one of our conveyors to fit your application parameters – give us a call. Below are a few custom solutions we have created.

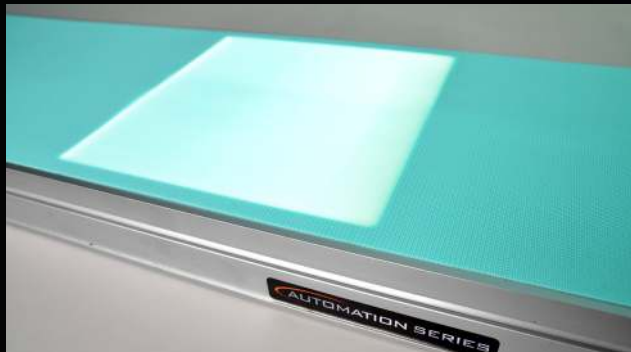

## Backlighting

Our conveyors can be modified to accept a wide variety of customer-specified backlights for vision applications. When coupled with a translucent belt, the conveyor creates an ideal platform for inspection as parts travel past.



## Custom Stands & Side Tables

We're often asked to design special stands to accommodate each customer's unique requirements. In this pack-off line, candy came in from the wrapping machines and was packed by hand into boxes coming in from the box erector. The filled boxes then left on a third line of conveyors for shrink wrapping. The application required custom stands and stainless steel side tables where operators packed the boxes.



## Multiple Bands

In this application, our customer needed to perform an operation on the bottom of a part as it moved across the conveyor. Our solution involved running two belts on the conveyor with a cutout between them. The part straddled the two belts and a robot performed the operation from below through the cutout.



## Elevator Conveyors

For an application that required product to move across a healthcare packaging plant, we devised an elevator system to elevate the bins to move overhead across the plant. The system consisted of two IS300 Indexing Conveyors with an IS175-ID Conveyor mounted between them. After bins moved onto the IS175-ID conveyor, the IS300 conveyors moved in tandem to raise the IS175-ID conveyor, which then moved the bins onto the overhead conveyor system.

# 24/7 Online Quoting

Configure and quote conveyors 24 hours a day using our online Conveyor Configurator. An intelligent assistant uses engineer-developed rules to make sure all your components – including drives, stands, and sides/guides – work together properly.

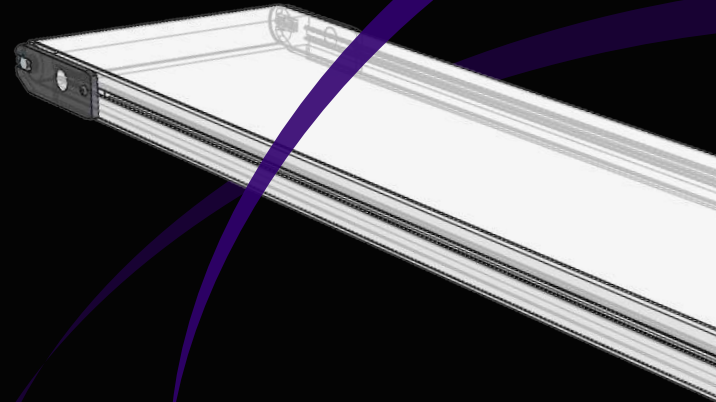

## Conveyor Configurator

Fast, intelligent online configuration and quoting



### Fast, Intelligent, Online

- » Manage multiple conveyors in a single quote using separate bills of materials
- » Our algorithms identify any errors and offer options for making corrections
- » Register your conveyor to qualify for our 10 Year Warranty
- » Access appropriate manuals and videos by serial number to make maintenance easy
- » View past orders and quote replacement parts directly from the original bills of materials, complete with exploded views to help you find exactly the right part

### Download 3D CAD Models

Once you've designed a conveyor with the *Conveyor Configurator*, you can download all the 3D CAD models, exploded views and specifications in one package to make integration with your application easy. We've included sides/guides, drives, stands and automation accessories, so it's easy to drop the complete conveyor system directly into your application.





## 10 Year Limited Warranty

Our products are developed and tested with long-term reliability in mind. To ensure our conveyors will run problem-free in the field for many years, we demand the tightest tolerances in the industry and manufacture our components using the most advanced processes available. Each conveyor is inspected at several points of the manufacturing process to ensure quality, including a final operational test before it leaves our facility. That's why we confidently stand behind our products with a 10 year warranty when they're registered at [qcconveyors.com/serial](http://qcconveyors.com/serial).



## 5 Day Lead Times

Many of our most popular conveyors are now available with just a five day lead time. Several of our most popular belt options are available for quick shipment. Look for the Quick Ship icon in our Conveyor Configurator to guide your selections and ensure a five day lead time!



## Why QC Conveyors?



For more than 35 years, we've been focused on one thing: providing our customers with reliable, easy to use conveyor systems that meet their needs, then backing them with world class service and support. Whether you're an end user looking to decrease your line's downtime or an OEM putting our conveyor in a machine with your company's name on it, QC Conveyors offers the quality, reliable product you're looking for.

We view our customers as partners, not for a single sale but for the long run. We regularly meet with them to learn how our products can better meet their needs and work hard to incorporate those needs into our products, leading to innovations like Tension Release tails and the pull-pin disassembly process of our HC200 Conveyors. In addition, we have a dedicated team of customer service professionals ready to assist in any way they can, each empowered with the flexibility to keep customers happy.



We invite you to visit our state of the art headquarters in Cincinnati, Ohio, where you can get your hands on our product and see first hand how easy it is to use and maintain. Once you do, we're confident you'll be a customer for life.

# Learn More

## Product-Specific Literature

Our product literature contains a wealth of information, including detailed specifications and information on sides/guides, drives, supports and accessories. Contact QC Conveyors or your local distributor to request a copy or download at [qcconveyors.com/literature](http://qcconveyors.com/literature).



## qcconveyors.com

QC Conveyors' website — [qcconveyors.com](http://qcconveyors.com) — is your resource for the most up-to-date information about all of our products.



## Conveyor Configurator

Configure conveyors online, 24 hours a day. See page 10 for more information.



## Your Local Distributor

Contact our sales department today at (513) 753-6000 to find your local distributor.



CONVEYOR SELECTION GUIDE



(513) 753-6000 | [qcconveyors.com](http://qcconveyors.com) | Part # MKTG-CSG-1901



THE DURAVANT FAMILY OF COMPANIES

ARPAQ | FISCHBEIN INTERNATIONAL | FMH CONVEYORS | HAMER-FISCHBEIN | KEY TECHNOLOGY | MARLEN INTERNATIONAL | MESPACK | OHLSON | QC CONVEYORS

[www.duravant.com](http://www.duravant.com)