

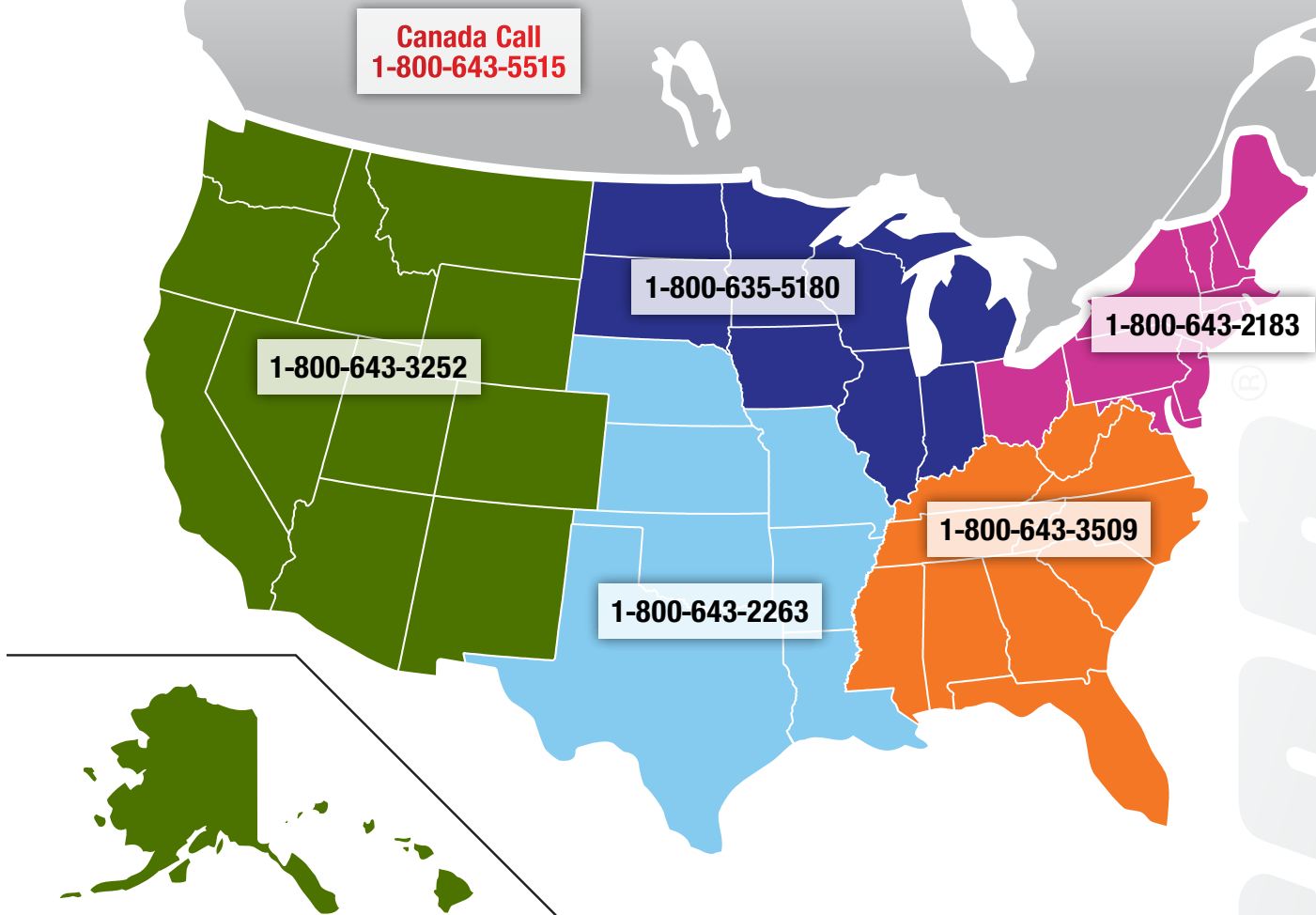

**colson**<sup>®</sup>  
[www.colsoncaster.com](http://www.colsoncaster.com)



# World Class Casters Backed by the Best Support Team in the Business



## Where Tradition and Technology Meet Teamwork

For over 125 years, Colson has been writing the science of caster technology with you in mind. From industry-changing innovations, to cost-cutting efficiencies, Colson continues its commitment to you—our customer.

At Colson, we believe success comes from providing expert solutions for our customers and unmatched support to our distributors. Our account management teams are dedicated to ensuring you get exactly what you need, when you need it. In fact, Colson regional managers are in the field every day, actively seeking opportunities to solve material handling problems. Colson offers over 35,000 different caster models—call and put their expertise to work for you when deciding which caster best fits your particular need.

Every Colson Distributor has years of experience, a wealth of Colson product knowledge, and stands ready to recommend the exact Colson caster for your application.

Enjoy our 2013 Mini-Catalog as a "snapshot" of what Colson offers. If you're ready to make a purchase or have questions, call us or visit the "Where to Buy" page on our website, [www.colsoncaster.com](http://www.colsoncaster.com).

Scan here for an interactive catalog of Colson's full product offering!



[www.ColsonCaster.com](http://www.ColsonCaster.com)

Phone: 1-800-643-5515 • Fax: 1-800-356-6708 or 1-800-230-2529

## Industry-Leading Colson Warranty:

Each Colson branded product is warranted against defects in material and workmanship for **three years** from the date of original purchase, unless it has been misused, abused, modified or improperly installed. Any product that is claimed to be defective that is returned to Colson with its approval will be repaired or replaced free of charge (excluding freight and installation). This warranty is exclusive and there are no other warranties, express or implied, such as an implied warranty of merchantability or fitness for particular purpose. This remedy is the sole remedy in contract, tort or otherwise, and Colson is not liable for incidental, consequential or special damages.

## 3D Models Available at [www.colsoncaster.com](http://www.colsoncaster.com)!

3D models for Colson Series 1 through 8, plus floor locks and some specialty casters are online! In this fast-paced manufacturing environment, you need a quick and effective way to incorporate Colson products directly into your own designs. Just click the “build 3D model” icon from our website’s homepage to start building a caster to your specifications by using the drop down menus. Our 3D models are available for download in various file formats for today’s latest engineering design programs.

As always, should a design require additional specifications, Colson’s product engineers will create a custom solution for you—not to mention a 3D model!



## How to Select the Proper Caster & Wheel

There is no simple formula or rule that can be followed in selecting the proper casters. Many varying and individual factors must be balanced to make the selection that will do the best job for you. The following are several of the more important considerations.

**Load Weight.** The heavier the load, the larger the wheel required for the caster. The weight of the load also influences the mobility of the wheel. Roller or ball bearings are recommended for loads over 400 pounds. Weight capacities are shown for each caster in this catalog.

**Floor Conditions.** Make sure the wheel you select is large enough to pass over cracks in the floor, tracks, moldings and other obstructions. For floor protection on linoleum, tile, carpet, etc., use polyurethane or Performa rubber wheels.

**Unusual Conditions.** Each wheel material has certain characteristics which will give the best results where unusual conditions exist. For example, where acids, oils, chemicals and other conditions harmful to rubber are present, Colson polyurethane, polyolefin, Maxim, phenolic or steel wheels are recommended. Check conditions, then select the caster and wheel.

**Rolling Ease.** The larger the wheel diameter, the easier it rolls. Roller bearings carry heavier loads.

### Caster Terms

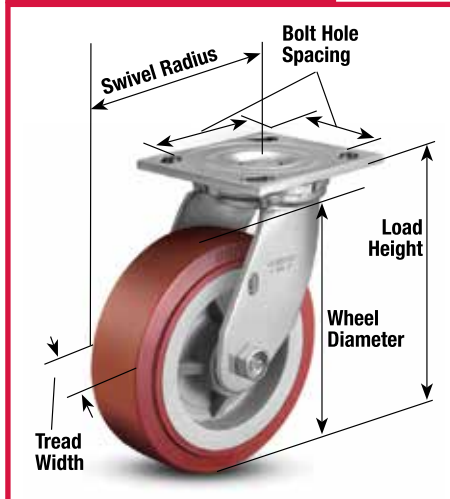

Ball bearings roll easier but carry lesser loads. When possible, use the largest ball bearing wheel for best results.

**Extreme Climates.** Room temperatures are no problem for most casters. But extreme cold or heat can be a problem. Colson helps solve this problem with “Colson 45”—the green lube which assures caster rolling ease from 45°F below zero to 260°F above. It’s standard on most Colson

### Wheel Terms



Photo above shows typical wheel. Bearings, bushings, etc. may vary with different wheel types.

casters. (**Note:** Some wheel types should not be used in extreme temperature ranges. Consult factory).

**Your Local Distributor.** Colson casters are available from stocking distributors across the U.S., Canada, & Mexico. Each is a caster specialist who can help you select the proper caster to suit your needs. Visit our website ([www.colsoncaster.com](http://www.colsoncaster.com)), or contact us for details at 1-800-643-5515.

## Associations / Memberships:

Colson Caster proudly displays these organizations and associations to express our commitment to continuously improving our products and processes.



## Bearing Options



### Delrin® Bearing

Delrin, a DuPont engineered plastic, is extremely durable under a wide range of temperature and humidity conditions, as well as is corrosion resistant. One piece or two piece Delrin models are available.



### Annular Ball Bearing

Annular ball bearings are precision type bearings with machined, hardened raceways. This bearing is for applications where maximum rolling ease and quiet operation are needed and best suited for light to medium duty loads.



### Precision Sealed Ball Bearing

Recommended for maximum rolling ease with no maintenance lubrication required, this quiet operating bearing is for medium duty to heavy duty loads.



### Roller Bearing

The roller bearing is capable of carrying a greater load than the same size diameter ball bearing. They also help absorb thrust friction. Also available in stainless steel. (Note: roller bearing must be used with hardened spanner bushing or hardened shaft.)



### Torrington-Style Roller Bearing

Colson's Torrington-style caged drawn cup bearings have a steel cage that provides inward retention of the needle rollers. This design provides maximum cage strength consistent with long service life. (Note: Must be used with hardened spanner bushing or hardened shaft.)



### Pedestal Precision Ball Bearing

This bearing is perfect when excellent rolling ease and quiet operation are required for your application. There is no maintenance grease required. The integrated spanner bushing makes installation easy. Available in stainless steel, too!

## Brake Options



### 1 Series Side Lock Brake

Capacity up to 145 lbs each

The ends of the brake spring are crimped so they grab the wheel at four contact points.



### L Series Side Lock Brake

Capacity up to 150 lbs each

This brake design grabs the wheel to provide strong holding power on L Series TPR and Polyolefin wheels, as well as LTS and LGR 2" models.



### L Series Top Lock Brake

Capacity up to 150 lbs each

The L Series Top Lock brake is available on most L Series casters and provides reliable braking action under a variety of operating conditions.



### 2 Series Top Lock Brake

Capacity up to 325 lbs each

Colson Top Lock brakes provide positive braking action, and a special cam activated brake mechanism locks firmly. Also available in stainless steel.



### 2 Series Total Lock® Brake

Capacity up to 325 lbs each

Colson's Total Lock brake locks the wheel and swivel simultaneously. The brake design features durable metal construction with a thermoplastic pedal. Also available in stainless steel.



### 2 Series Directional Lock

Capacity to 325 lbs each

Lock the swivel for straight tracking on all 2 Series top plate swivel casters. The foot-activated directional lock engages simply and securely into lead or trailing position.



### G Series Side Lock Brake

Capacity to 350 lbs each

This side locking brake design grabs the wheel to provide reliable holding power. Available on all GDP swivel model casters.



### 4 Series Side Lock Brake

Capacity to 1400 lbs each

Colson's 4 Series Side Lock brake design places a positive locking force against the wheel hub to hold loads securely. The larger foot pedal makes the brake easier to operate. Also available in stainless steel.



### 4 Series Top Lock Brake

Capacity up to 1400 lbs each

Colson 4 Series forks include a special notch for easy installation of Top Lock brakes. The brake is cost effective and reliable. Also available in stainless steel.



### 4 Series Swivel Tech Lock® Brake

Capacity up to 1250 lbs each

Constructed of durable, light-weight engineered thermoplastics, this brake is ideally suited for wet or corrosive conditions. A specially engineered design is also available for 6" rigid casters. Also available in stainless steel.



### 4 Series Total Lock® Brake

Capacity up to 1250 lbs each

With a press of the foot, lock both the wheel and swivel in any position. The contemporary design features thermoplastic construction to resist rust and corrosion.



### 4 & 6 Series Tread Lock Brake

Capacity up to 1500 lbs each

This adjustable brake can be installed in the field or ordered assembled onto the caster. The toe activated brake features positive engagement via rubber faced plate.



### 7 & 8 Series Enforcer Tread Lock Brake

Capacity up to 4500 lbs each

This toe activated Tread Lock brake features positive engagement via a single rubber faced plate.

# 1 Series

- Expanding Adapter Stem
- Capacity up to 145 lbs each



## Colson 1 Series Casters • Expanding Adapter Stem • Capacity to 145 lbs each

Wheel Dia.	Tread Width	Capacity Each (Pounds)	Wheel Descriptions	Wheel Bearing	Stem Caster Models*	Load Height	Swivel Radius	Weight (Pounds)
3"	7/8"	100	Polyurethane HI-TECH	Delrin	1.03367.91	37/8	2 <sup>13</sup> / <sub>16</sub>	1 <sup>1</sup> / <sub>4</sub>
		125	Performa Rubber	Delrin	1.03367.441	37/8	2 <sup>13</sup> / <sub>16</sub>	1 <sup>1</sup> / <sub>4</sub>
			Polyolefin	Delrin	1.03367.53	37/8	2 <sup>13</sup> / <sub>16</sub>	1 <sup>1</sup> / <sub>4</sub>
4"	7/8"	125	Polyurethane HI-TECH	Delrin	1.04367.91	47/8	37/16	1 <sup>1</sup> / <sub>2</sub>
		135	Performa Rubber	Delrin	1.04367.441	47/8	37/16	1 <sup>1</sup> / <sub>2</sub>
			Polyolefin	Delrin	1.04367.53	47/8	37/16	1 <sup>1</sup> / <sub>2</sub>
5"	7/8"	140	Polyurethane HI-TECH	Delrin	1.05367.91	57/8	4 <sup>1</sup> / <sub>16</sub>	1 <sup>3</sup> / <sub>4</sub>
		145	Performa Rubber	Delrin	1.05367.441	57/8	4 <sup>1</sup> / <sub>16</sub>	1 <sup>3</sup> / <sub>4</sub>
			Polyolefin	Delrin	1.05367.53	57/8	4 <sup>1</sup> / <sub>16</sub>	1 <sup>3</sup> / <sub>4</sub>

\*To order, select caster model number and specify stem adapter size code from mounting options chart.

### Standard Features

- Zinc plated finish
- Full double ball hardened raceways
- 5/16" shouldered axle with 1/4" nut
- "Colson 45" multi-temp lube

### Mounting Options

Inside Diameter of Tube	Mounting Code Numbers	
	Round Tubing	Square Tubing
3/4" - 13/16"	MTG40	-
7/8" - 15/16"	MTG41	MTG51
1" - 1 1/16"	MTG42	MTG52
1 1/8" - 1 3/16"	MTG43	MTG53
1 1/4" - 1 5/16"	MTG44	MTG54
1 3/8" - 1 7/16"	MTG45	MTG55
1 1/2" - 1 9/16"	MTG46	-
1 5/8" - 1 11/16"	MTG47	-

Stems are 2 11/16" long. Stem size less adapter: 1/2" - 13UNC x 2 11/16"

### Options

- Side Lock Brake
- NSF Listed
- Thread Guards

### Standard Dimensions

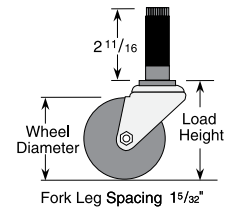

# 1 Series

- Large Top Plate Swivel and Rigid
- Capacity up to 145 lbs each



## Colson 1 Series Casters • Large Top Plate Swivel and Rigid • Capacity to 145 lbs each

Wheel Dia.	Tread Width	Capacity Each (Pounds)	Wheel Descriptions	Wheel Bearing	Swivel Top Plate Caster Models	Rigid Top Plate Caster Models	Load Height	Swivel Radius	Weight (Pounds)
3"	7/8"	100	Polyurethane HI-TECH	Delrin	1.03356.91	1.03008.91	33/4	2 <sup>13</sup> / <sub>16</sub>	1 <sup>1</sup> / <sub>4</sub>
		125	Performa Rubber	Delrin	1.03356.441	1.03008.441	33/4	2 <sup>13</sup> / <sub>16</sub>	1 <sup>1</sup> / <sub>4</sub>
			Polyolefin	Delrin	1.03356.53	1.03008.53	33/4	2 <sup>13</sup> / <sub>16</sub>	1 <sup>1</sup> / <sub>4</sub>
4"	7/8"	125	Polyurethane HI-TECH	Delrin	1.04356.91	1.04008.91	43/4	37/16	1 <sup>1</sup> / <sub>2</sub>
		135	Performa Rubber	Delrin	1.04356.441	1.04008.441	43/4	37/16	1 <sup>1</sup> / <sub>2</sub>
			Polyolefin	Delrin	1.04356.53	1.04008.53	43/4	37/16	1 <sup>1</sup> / <sub>2</sub>
5"	7/8"	140	Polyurethane HI-TECH	Delrin	1.05356.91	1.05008.91	53/4	4 <sup>1</sup> / <sub>16</sub>	1 <sup>3</sup> / <sub>4</sub>
		145	Performa Rubber	Delrin	1.05356.441	1.05008.441	53/4	4 <sup>1</sup> / <sub>16</sub>	1 <sup>3</sup> / <sub>4</sub>
			Polyolefin	Delrin	1.05356.53	1.05008.53	53/4	4 <sup>1</sup> / <sub>16</sub>	1 <sup>3</sup> / <sub>4</sub>

### Standard Features

- Zinc plated finish
- Full double ball hardened raceways
- 5/16" shouldered axle with 1/4" nut
- .090" steel top plate
- "Colson 45" multi-temp lube

### Standard Dimensions

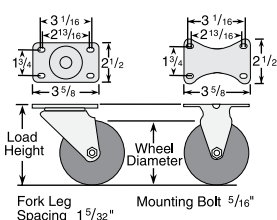

### Options

- Side Lock Brake
- NSF Listed
- Thread Guards

# Light Duty Casters Series

- Top Plate Swivel and Rigid
- Threaded Stem
- Grip Ring Stem
- Capacity up to 150 lbs each

www.colsoncaster.com



## Colson L Series LTP Casters • Top Plate Swivel and Rigid • Capacity to 150 lbs

Wheel Dia.	Tread Width	Capacity Each (Pounds)	Wheel Descriptions	Wheel Bearing	Swivel Top Plate Models	Rigid Top Plate Models	Load Height	Swivel Radius	Weight (Pounds)
3"	13/16"	90	TPR	Plain	LTP3356142	LTP3308142	3 3/4	2 3/4	3/4
		110	Polyolefin	Plain	LTP3356152	LTP3308152	3 3/4	2 3/4	3/4
4"	15/16"	115	TPR	Plain	LTP0456142	LTP0408142	4 13/16	3 5/16	1
		140	Polyolefin	Plain	LTP0456152	LTP0408152	4 13/16	3 5/16	1
5"	15/16"	125	TPR	Plain	LTP0556142	LTP0508142	5 13/16	3 5/16	1 1/4
		150	Polyolefin	Plain	LTP0556152	LTP0508152	5 13/16	3 5/16	1 1/4

## Colson L Series LTS Casters • Threaded Stem • Capacity to 150 lbs

Wheel Dia.	Tread Width	Capacity Each (Pounds)	Wheel Descriptions	Wheel Bearing	Threaded Stem Caster Models	Load Height	Swivel Radius	Weight (Pounds)	Stem Size
2"	3/4"	80	TPR	Plain	LTS0254542	2 17/32	1 13/16	1/4	3/8" dia. 16NC x 1 1/2" long
3"	13/16"	90	TPR	Plain	LTS3354542	3 1/2	2 19/32	3/4	3/8" dia. 16NC x 1 1/2" long
		110	Polyolefin	Plain	LTS3354552	3 1/2	2 19/32	3/4	
4"	15/16"	115	TPR	Plain	LTS0454342	4 11/16	3 9/32	1	1/2" dia. 13NC x 1 1/2" long
		140	Polyolefin	Plain	LTS0454352	4 11/16	3 9/32	1	
5"	15/16"	125	TPR	Plain	LTS0554342	5 23/32	3 3/4	1 1/4	1/2" dia. 13NC x 1 1/2" long
		150	Polyolefin	Plain	LTS0554352	5 23/32	3 3/4	1 1/4	

## Colson L Series LGR Casters • Grip Ring • Capacity to 150 lbs

Wheel Dia.	Tread Width	Capacity Each (Pounds)	Wheel Descriptions	Wheel Bearing	Grip Ring Stem Caster Models	Load Height	Swivel Radius	Weight (Pounds)	Stem Size
2"	3/4"	80	TPR	Plain	LGR0251242	2 17/32	1 13/16	1/4	7/16" dia. x 1 3/8" long
3"	13/16"	90	TPR	Plain	LGR3351242	3 1/2	2 19/32	3/4	7/16" dia. x 1 3/8" long
		110	Polyolefin	Plain	LGR3351252	3 1/2	2 19/32	3/4	
4"	15/16"	115	TPR	Plain	LGR0451342	4 5/8	3 9/32	1	7/16" dia. x 1 17/32" long
		140	Polyolefin	Plain	LGR0451352	4 5/8	3 9/32	1	
5"	15/16"	125	TPR	Plain	LGR0551342	5 5/8	3 3/4	1 1/4	7/16" dia. x 1 17/32" long
		150	Polyolefin	Plain	LGR0551352	5 5/8	3 3/4	1 1/4	

### Standard Features

- Zinc plated finish
- Full double ball hardened raceways
- Standard models feature riveted axle; brake models feature nut and bolt

### Standard Dimensions

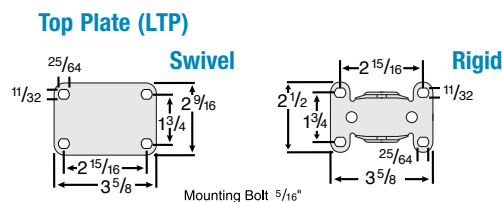

### Options

- Side and Top Lock Brakes
- NSF Listed
- RoHS Compliant

# 2 Series

- Expanding Adapter Stem
- Capacity up to 325 lbs each



## Colson 2 Series Casters • Expanding Adapter Stem • Capacity to 325 lbs

Wheel Dia.	Tread Width	Capacity Each (Pounds)	Wheel Descriptions	Wheel Bearing	Stem Caster Models**	Load Height	Swivel Radius	Weight (Pounds)
3 1/2"	1 5/16"	210	Perfoma Rubber (Round)	Delrin*	2.03267.561	4 9/16	2 29/32	2 1/4
		230	Polyolefin	Delrin*	2.03267.53	4 9/16	2 29/32	2 1/8
	1 1/4"	250	Perfoma Rubber (Flat)	Delrin*	2.03267.441	4 9/16	2 29/32	2 1/8
			Polyurethane HI-TECH	Delrin*	2.03267.91	4 9/16	2 29/32	1 3/4
4"	1 1/4"	275	Polyolefin	Delrin*	2.04267.53	5 1/4	3 7/32	2 1/4
			Polyurethane HI-TECH	Delrin*	2.04267.91	5 1/4	3 7/32	2
		300	Perfoma Rubber (Flat)	Delrin*	2.04267.441	5 1/4	3 7/32	2 1/4
5"	1 5/16"	250	Perfoma Rubber (Round)	Delrin*	2.05267.561	6 5/16	3 13/16	3
			Polyolefin	Delrin*	2.05267.53	6 5/16	3 13/16	2 3/4
	1 1/4"	300	Polyurethane HI-TECH	Delrin*	2.05267.91	6 5/16	3 13/16	2 1/2
			325	Perfoma Rubber (Flat)	Delrin*	2.05267.441	6 5/16	3 13/16

\*Ball bearing model available; change last digit to "5" (Example: 2.03267.565 MTG40).

\*\*To order, select caster model number and specify stem adapter size code number from mounting options chart.

### Standard Features

- Zinc plated finish
- Full double ball hardened raceways
- 3/8" hollow axle with lock nut
- "Colson 45" multi-temp lube
- Also available in Encore by Colson, consult factory.

### Mounting Options

Inside Diameter of Tube	Mounting Code Numbers	
	Round Tubing	Square Tubing
3/4" - 13/16"	MTG40	-
7/8" - 15/16"	MTG41	MTG51
1" - 1 1/16"	MTG42	MTG52
1 1/8" - 1 9/16"	MTG43	MTG53
1 1/4" - 1 5/16"	MTG44	MTG54
1 3/8" - 1 7/16"	MTG45	MTG55
1 1/2" - 1 9/16"	MTG46	-
1 5/8" - 1 11/16"	MTG47	-

Stems are 2 11/16" long. Stem size less adapter: 1/2" - 13UNC x 2 11/16"

### Standard Dimensions

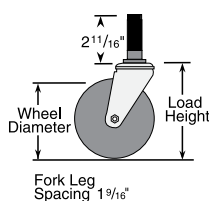

### Options

- Top and Total Lock Brakes
- Thread Guards
- Swivel Dust Cap
- NSF Listed

# 2 Series

- Grip Ring Stem
- Capacity up to 325 lbs each



## Colson 2 Series Casters • Grip Ring Stem • Capacity to 325 lbs

Wheel Dia.	Tread Width	Capacity Each (Pounds)	Wheel Descriptions	Wheel Bearing	Stem Caster Models	Load Height	Swivel Radius	Weight (Pounds)	
3 1/2"	1 1/4"	210	Perfoma Rubber (Round)	Delrin*	2.03251.561	4 9/16	2 29/32	2 1/4	
		225	Perfoma Rubber (Conductive/Flat)	Ball	2.03251.445 COND	4 9/16	2 29/32	2	
			TPE HI-TEMP	Prec. Ball	2.03251.414 H	4 9/16	2 29/32	2 1/8	
		230	Polyolefin	Delrin*	2.03251.53	4 9/16	2 29/32	2 1/8	
		250	Perfoma Rubber (Flat)	Delrin*	2.03251.441	4 9/16	2 29/32	2 1/8	
			Polyurethane HI-TECH	Delrin*	2.03251.91	4 9/16	2 29/32	1 3/4	
300	Thermo	Plain	2.03251.52 HT	4 9/16	2 29/32	2 7/8			
4"	1 1/4"	250	ThermoTech	Teflon	2.04251.613 H	5	3 7/32	3	
			Perfoma Rubber (Conductive/Flat)	Ball	2.04251.445 COND	5	3 7/32	2 1/4	
			TPE HI-TEMP	Prec. Ball	2.04251.414 H	5	3 7/32	2 1/4	
		275	Polyolefin	Delrin*	2.04251.53	5	3 7/32	2 1/4	
			Polyurethane HI-TECH	Delrin*	2.04251.91	5	3 7/32	2	
			300	Perfoma Rubber (Flat)	Delrin*	2.04251.441	5	3 7/32	2 1/4
Thermo	Plain	2.04251.52 HT		5	3 7/32	3 1/8			
5"	1 1/4"	250	ThermoTech	Teflon	2.05251.613 H	6 1/16	3 13/16	3	
			Perfoma Rubber (Conductive/Flat)	Ball	2.05251.445 COND	6 1/16	3 13/16	3	
	1 5/16"	250	Perfoma Rubber (Round)	Delrin*	2.05251.561	6 1/16	3 13/16	3	
			Polyolefin	Delrin*	2.05251.53	6 1/16	3 13/16	2 3/4	
			Polyurethane HI-TECH	Delrin*	2.05251.91	6 1/16	3 13/16	2 1/2	
			TPE HI-TEMP	Prec. Ball	2.05251.414 H	6 1/16	3 13/16	2 1/2	
			300	Perfoma Rubber (Flat)	Delrin*	2.05251.441	6 1/16	3 13/16	2 3/4
				Thermo	Plain	2.05251.52 HT	6 1/16	3 13/16	3 1/2

\*Ball bearing model available; change last digit to "5" (Example: 2.03251.565).

### Standard Features

- Zinc plated finish
- Full double ball hardened raceways
- 3/8" hollow axle with lock nut
- "Colson 45" multi-temp lube
- Also available in Encore by Colson, consult factory.

### Mounting Options

- MTG2: 1 1/2" long x 7/16" dia. (.437)
- MTG5: 2 3/16" long x 3/4" dia. (.75)
- MTG6: 2 3/16" long x 13/16" dia. (.812)
- MTG7: 2 3/16" long x 27/32" dia. (.845)
- MTG8: 2 3/16" long x 7/8" dia. (.875)
- MTG9: 2 3/16" long x 1" dia. (1.00)

### Standard Dimensions

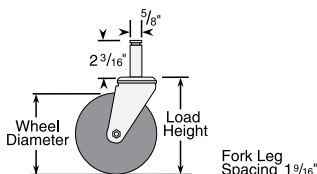

### Options

- Top and Total Lock Brakes
- Thread Guards
- Swivel Dust Cap
- NSF Listed

# 2 Series

- Straight Thread Stem
- Capacity up to 325 lbs each



### Standard Features

- Zinc plated finish
- Full double ball hardened raceways
- 3/8" hollow axle with lock nut
- "Colson 45" multi-temp lube
- Also available in Encore by Colson, consult factory.

### Mounting Options

- MTG10: 1/2" 13UNC x 3/4" long threaded
- MTG11: 1/2" 13UNC x 1" long threaded
- MTG12: 1/2" 20UNF x 3/4" long threaded
- MTG13: 5/8" 11UNC x 1 3/4" long threaded
- MTG14: 5/8" 18UNF x 1 3/4" long threaded
- MTG15: 3/4" 10UNC x 1 3/4" long threaded
- MTG50: 1/2" 20UNF x 1 1/2" long threaded

### Standard Dimensions

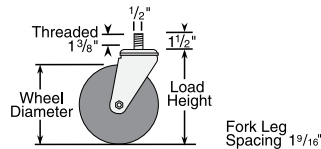

### Options

- Top and Total Lock Brakes
- Thread Guards
- Swivel Dust Cap
- NSF Listed

## Colson 2 Series Casters • Straight Thread Stem • Capacity to 325 lbs

Wheel Dia.	Tread Width	Capacity Each (Pounds)	Wheel Descriptions	Wheel Bearing	Stem Caster Models	Load Height	Swivel Radius	Weight (Pounds)	
3 1/2"	1 5/16"	210	Perma Rubber (Round)	Delrin*	2.03254.561	4 9/16	2 29/32	2 1/4	
		225	Perma Rubber (Conductive/Flat)	Ball	2.03254.445 COND	4 9/16	2 29/32	2	
	1 1/4"	230	TPE HI-TEMP	Prec. Ball	2.03254.414 H	4 9/16	2 29/32	2 1/8	
		250	Polyolefin	Delrin*	2.03254.53	4 9/16	2 29/32	2 1/8	
		250	Perma Rubber (Flat)	Delrin*	2.03254.441	4 9/16	2 29/32	2 1/8	
4"	1 1/4"	250	Polyurethane HI-TECH	Delrin*	2.03254.91	4 9/16	2 29/32	1 3/4	
		300	Thermo	Plain	2.03254.52 HT	4 9/16	2 29/32	3 1/8	
		250	ThermoTech	Teflon	2.04254.613 H	5	3 7/32	3	
		250	Perma Rubber (Conductive/Flat)	Ball	2.04254.445 COND	5	3 7/32	2 1/4	
		275	TPE HI-TEMP	Prec. Ball	2.04254.414 H	5	3 7/32	2 1/4	
5"	1 1/4"	250	Polyolefin	Ball	2.04254.55	5	3 7/32	2 1/4	
		250	Polyurethane HI-TECH	Delrin*	2.04254.91	5	3 7/32	2	
	1 1/4"	250	Perma Rubber (Flat)	Delrin*	2.04254.441	5	3 7/32	2 1/4	
		300	Thermo	Plain	2.04254.52 HT	5	3 7/32	3 1/4	
		250	ThermoTech	Teflon	2.05254.613 H	6 1/16	3 13/16	3	
		250	Perma Rubber (Conductive/Flat)	Ball	2.05254.445 COND	6 1/16	3 13/16	3	
		1 5/16"	250	Perma Rubber (Round)	Delrin*	2.05254.561	6 1/16	3 13/16	3
			250	Polyolefin	Delrin*	2.05254.53	6 1/16	3 13/16	2 3/4
	1 1/4"	300	300	Polyurethane HI-TECH	Delrin*	2.05254.91	6 1/16	3 13/16	2 1/2
			300	TPE HI-TEMP	Prec. Ball	2.05254.414 H	6 1/16	3 13/16	2 1/2
300			Cast Iron	Sleeve	2.05254.12	6 1/16	3 13/16	3 3/4	
325			Perma Rubber (Flat)	Delrin*	2.05254.441	6 1/16	3 13/16	2 3/4	
		325	Thermo	Plain	2.05254.52 HT	6 1/16	3 13/16	3 3/4	

\*Ball bearing model available; change last digit to "5" (Example: 2.03254.95).

# 2 Series

- Top Plate Swivel & Rigid
- Capacity up to 325 lbs each



### Standard Features

- Zinc plated finish
- Full double ball hardened raceways
- 3/8" hollow axle with lock nut
- "Colson 45" multi-temp lube
- Also available in Encore by Colson, consult factory.

### Standard Dimensions

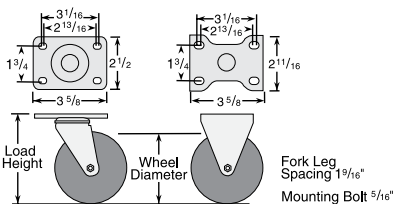

## Colson 2 Series Casters • Top Plate Swivel & Rigid • Capacity to 325 lbs

Wheel Dia.	Tread Width	Capacity Each (Pounds)	Wheel Descriptions	Wheel Bearing	Swivel Top Plate Caster Models**	Load Height	Swivel Radius	Weight (Pounds)	
3 1/2"	1 5/16"	210	Perma Rubber (Round)	Delrin*	2.03256.561	4 11/16	2 29/32	2 1/4	
		225	Perma Rubber (Conductive/Flat)	Ball	2.03256.445 COND	4 11/16	2 29/32	2	
	1 1/4"	230	TPE HI-TEMP	Prec. Ball	2.03256.414 H	4 11/16	2 29/32	1 7/8	
		250	Polyolefin	Delrin*	2.03256.53	4 11/16	2 29/32	1 7/8	
		250	Perma Rubber (Flat)	Delrin*	2.03256.441	4 11/16	2 29/32	2	
4"	1 1/4"	250	Polyurethane HI-TECH	Delrin*	2.03256.91	4 11/16	2 29/32	1 7/8	
		300	Thermo	Plain	2.03256.52 HT	4 11/16	2 29/32	2 7/8	
		250	ThermoTech	Teflon	2.04256.613 H	5 1/8	3 7/32	3	
		250	Perma Rubber (Conductive/Flat)	Ball	2.04256.445 COND	5 1/8	3 7/32	2 1/4	
		275	TPE HI-TEMP	Prec. Ball	2.04256.414 H	5 1/8	3 7/32	2 1/8	
5"	1 1/4"	250	Polyolefin	Ball	2.04256.55	5 1/8	3 7/32	2 1/8	
		250	Polyurethane HI-TECH	Delrin*	2.04256.91	5 1/8	3 7/32	2 1/8	
	1 1/4"	250	Perma Rubber (Flat)	Delrin*	2.04256.441	5 1/8	3 7/32	2 1/4	
		300	Thermo	Plain	2.04256.52 HT	5 1/8	3 7/32	3 1/8	
		250	ThermoTech	Teflon	2.05256.613 H	6 3/16	3 13/16	3	
		250	Perma Rubber (Conductive/Flat)	Ball	2.05256.445 COND	6 3/16	3 13/16	3	
		1 5/16"	250	Perma Rubber (Round)	Delrin*	2.05256.561	6 3/16	3 13/16	3
			250	Polyolefin	Delrin*	2.05256.53	6 3/16	3 13/16	2 1/2
	1 1/4"	300	300	Polyurethane HI-TECH	Delrin*	2.05256.91	6 3/16	3 13/16	2 1/2
			300	TPE HI-TEMP	Prec. Ball	2.05256.414 H	6 3/16	3 13/16	2 1/2
300			Cast Iron	Sleeve	2.05256.12	6 3/16	3 13/16	3 3/4	
325			Perma Rubber (Flat)	Delrin*	2.05256.441	6 3/16	3 13/16	2 3/4	
		325	Thermo	Plain	2.05256.52 HT	6 3/16	3 13/16	3 1/2	

\*Ball bearing model available; change last digit to "5" (Example: 2.03256.445).

\*\*Rigid model available; change 5th and 6th digits to "08" (Example: 2.03208.561).

### Options

- Optional Top Plates
- Top and Total Lock Brakes
- Directional Lock
- Thread Guards
- Swivel Dust Cap
- NSF Listed



# 2 Series

- Square Stem Swivel & Rigid
- Capacity up to 325 lbs each



### Standard Features

- Zinc plated finish
- Full double ball hardened raceways
- 3/8" hollow axle with lock nut
- "Colson 45" multi-temp lube
- Also available in Encore by Colson, consult factory.

### Standard Dimensions

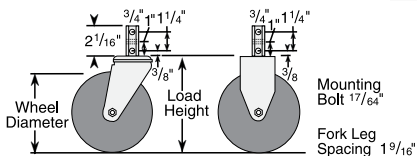

## Colson 2 Series Casters • Square Stem Swivel & Rigid • Capacity to 325 lbs

Wheel Dia.	Tread Width	Capacity Each (Pounds)	Wheel Descriptions	Wheel Bearing	Swivel Stem Caster Models**	Load Height	Swivel Radius	Weight (Pounds)
3 1/2"	1 5/16"	210	Perma Rubber (Round)	Delrin*	2.03270.561	4 9/16	2 29/32	2 1/4
		225	Perma Rubber (Conductive/Flat)	Ball	2.03270.445 COND	4 9/16	2 29/32	2
		230	TPE HI-TEMP	Prec. Ball	2.03270.414 H	4 9/16	2 29/32	1 7/8
	1 1/4"	250	Polyolefin	Delrin*	2.03270.53	4 9/16	2 29/32	1 7/8
		300	Perma Rubber (Flat)	Delrin*	2.03270.441	4 9/16	2 29/32	2
4"	1 1/4"	250	Polyurethane HI-TECH	Delrin*	2.03270.91	4 9/16	2 29/32	2 7/8
		300	Thermo	Plain	2.03270.52 HT	4 9/16	2 29/32	2 7/8
		250	ThermoTech	Teflon	2.04270.613 H	5	3 7/32	3
		250	Perma Rubber (Conductive/Flat)	Ball	2.04270.445 COND	5	3 7/32	2 1/4
		275	TPE HI-TEMP	Prec. Ball	2.04270.414 H	5	3 7/32	2 1/8
	1 5/16"	250	Polyolefin	Ball	2.04270.55	5	3 7/32	2 1/8
		275	Polyurethane HI-TECH	Delrin*	2.04270.91	5	3 7/32	2 1/8
		300	Perma Rubber (Flat)	Delrin*	2.04270.441	5	3 7/32	2 1/4
		300	Thermo	Plain	2.04270.52 HT	5	3 7/32	3 1/8
		325	ThermoTech	Teflon	2.05270.613 H	6 1/16	3 13/16	3
5"	1 1/4"	250	Perma Rubber (Conductive/Flat)	Ball	2.05270.445 COND	6 1/16	3 13/16	3
		250	Perma Rubber (Round)	Delrin*	2.05270.561	6 1/16	3 13/16	3
	1 5/16"	300	Polyolefin	Delrin*	2.05270.53	6 1/16	3 13/16	2 1/2
		300	Polyurethane HI-TECH	Delrin*	2.05270.91	6 1/16	3 13/16	2 1/2
		300	TPE HI-TEMP	Prec. Ball	2.05270.414 H	6 1/16	3 13/16	2 1/2
		300	Cast Iron	Sleeve	2.05270.12	6 1/16	3 13/16	3 3/4
		325	Perma Rubber (Flat)	Delrin*	2.05270.441	6 1/16	3 13/16	2 3/4
		325	Thermo	Plain	2.05270.52 HT	6 1/16	3 13/16	3 1/2

### Options

- Top and Total Lock Brakes
- Thread Guards
- Swivel Dust Cap
- Square and Octagon Stem Mountings
- NSF Listed

\*Ball bearing model available; change last digit to "5" (Example: 2.03270.565).  
 \*\*Rigid model available in 5" only; change 5th digit to "8" (Example: 2.05280.561).

# 2 Series

- Stainless Steel Top Plate Swivel & Rigid
- Capacity up to 325 lbs each



### Standard Features

- Polished 304 grade stainless steel construction
- Double ball raceways
- All component parts, including spanner bushing, axle and nut are stainless steel
- Designed to perform in the most hostile environments
- If rust is a problem... Colson stainless steel is the solution

## Colson 2 Series Casters • Stainless Steel Top Plate Swivel & Rigid • Capacity to 325 lbs

Wheel Dia.	Tread Width	Capacity Each (Pounds)	Wheel Descriptions	Wheel Bearing	Swivel Top Plate Caster Models*	Load Height	Swivel Radius	Weight (Pounds)
3"	1 1/4"	150	Rubber HI-TECH	Plain	2.33456.42	4 1/8	3 1/8	1 5/8
		200	Polyolefin	Delrin	2.33456.544	4 1/8	3 1/8	1 5/8
		200	Polyurethane HI-TECH	Plain	2.33456.944	4 1/8	3 1/8	1 5/8
3 1/2"	1 1/4"	225	TPE HI-TEMP	Prec. Ball	2.03456.414 H	4 11/16	3 3/8	1 5/8
		250	Polyolefin	Delrin	2.03456.544	4 11/16	3 3/8	1 5/8
		250	Polyurethane HI-TECH	Delrin	2.03456.944	4 11/16	3 3/8	1 7/8
		300	Perma Rubber (Flat)	Delrin	2.03456.444	4 11/16	3 3/8	1 3/4
		300	Thermo	Plain	2.03456.52 HT	4 11/16	3 3/8	1 5/8
	210	Perma Rubber (Round)	Delrin	2.03456.564	4 11/16	3 3/8	1 3/4	
4"	1 1/4"	250	ThermoTech	Teflon	2.04456.613 H	5 1/8	3 5/16	3
		250	TPE HI-TEMP	Prec. Ball	2.04456.414 H	5 1/8	3 5/16	1 5/8
		275	Polyolefin	Delrin	2.04456.544	5 1/8	3 5/16	2 1/8
		275	Polyurethane HI-TECH	Delrin	2.04456.944	5 1/8	3 5/16	2 1/8
		300	Perma Rubber (Flat)	Delrin	2.04456.444	5 1/8	3 5/16	2 1/4
		300	Thermo	Plain	2.04456.52 HT	5 1/8	3 5/16	2 1/4
		250	ThermoTech	Teflon	2.05456.613 H	6 3/16	4 1/16	3
5"	1 1/4"	300	Polyolefin	Delrin	2.05456.544	6 3/16	4 1/16	2 5/8
		300	Polyurethane HI-TECH	Delrin	2.05456.944	6 3/16	4 1/16	2 5/8
		300	TPE HI-TEMP	Prec. Ball	2.05456.414 H	6 3/16	4 1/16	1 5/8
		325	Perma Rubber (Flat)	Delrin	2.05456.444	6 3/16	4 1/16	2 3/4
	325	Thermo	Plain	2.05456.52 HT	6 3/16	4 1/16	2 3/4	
1 5/16"	250	Perma Rubber (Round)	Delrin	2.05456.564	6 3/16	4 1/16	2 3/4	

### Standard Dimensions

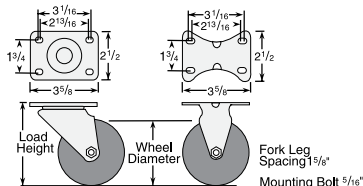

### Options

- Top, Tech and Total Lock Brakes
- Optional 1/2" ID Hollow King Pin Available
- NSF Listed

\*Rigid model available; change 5th and 6th digits to "08" (Example: 2.33408.42).

# G Series

Light Duty Casters

- Top Plate Swivel and Rigid
- Capacity to 350 lbs



## G Series Light Duty Casters • Top Plate Swivel and Rigid • Capacity to 350 lbs

Wheel Dia.	Tread Width	Capacity Each (Pounds)	Wheel Descriptions	Wheel Bearing	Swivel Top Plate Caster Models	Rigid Top Plate Caster Models	Load Height	Swivel Radius	Weight (Pounds)
2"	3/4"	90	TPR	Plain	GDP0256142	GDP0208142	2 1/2"	1 11/16"	1/2
	1"	150	Hard Rubber	Plain	GDP02561652	GDP02081652	2 1/2"	1 11/16"	1/2
Polyolefin			Plain	GDP0256152	GDP0208152	2 1/2"	1 11/16"	1/2	
2 1/2"	1 1/8"	200	Hard Rubber	Plain	GDP25561652	GDP25081652	3 3/16"	2 1/4"	3/4
			Polyolefin	Plain	GDP2556152	GDP2508152	3 3/16"	2 1/4"	3/4
3"	1 1/4"	180	TPR	Plain	GDP3356142	GDP3308142	3 13/16"	2 3/8"	1 1/4
			Hard Rubber	Plain	GDP33561652	GDP33081652	3 13/16"	2 3/8"	1 1/4
			Polyolefin	Plain	GDP3356152	GDP3308152	3 13/16"	2 3/8"	1 1/4
4"	1 5/16"	350	Hard Rubber	Plain	GDP04561652	GDP04081652	5"	3 3/16"	3
			Polyolefin	Plain	GDP0456152	GDP0408152	5"	3 3/16"	3

### Standard Features

- Zinc plated finish
- Single ball hardened raceway
- Nickel plated rivet helps prevent binding
- Standard models feature riveted axle, brake models feature nut and bolt

### Standard Dimensions

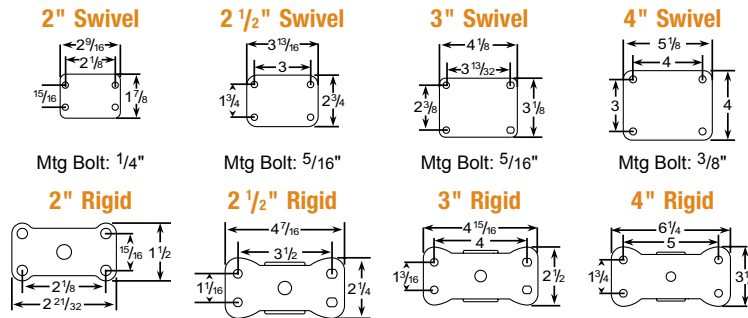

### Options

- Side Lock Brake
- NSF Listed and RoHS Compliant

# 3 Series

- Top Plate Swivel & Rigid
- Capacity up to 800 lbs each



## Colson 2 Series Casters • Top Plate Swivel & Rigid • Capacity to 325 lbs

Wheel Dia.	Tread Width	Capacity Each (Pounds)	Wheel Descriptions	Wheel Bearing*	Swivel Top Plate Caster Models**	Load Height	Swivel Radius	Weight (Pounds)
3"	1 1/2"	250	Perfoma Rubber (Flat/Grey)	Roller	3.00317.449	4 1/2"	3 1/8"	3
		300	Polyolefin	Roller	3.00317.809	4 1/2"	3 1/8"	2 3/4
		400	Polyurethane HI-TECH	Roller	3.00317.909	4 1/2"	3 1/8"	3
			Phenolic	Roller	3.00317.309	4 1/2"	3 1/8"	2 3/4
4"	1 1/2"	255	Perfoma Rubber (Conductive Flat)	Roller	3.00417.449 COND	5 3/8"	3 5/8"	3 1/2
		325	Perfoma Rubber (Flat/Grey)	Roller	3.00417.449	5 3/8"	3 5/8"	3 1/2
		375	Polyolefin	Roller	3.00417.809	5 3/8"	3 5/8"	3
		400	Polyurethane HI-TECH	Roller	3.00417.909	5 3/8"	3 5/8"	3 1/4
			Phenolic	Roller	3.00417.309	5 3/8"	3 5/8"	3 1/4
5"	1 1/2"	280	Perfoma Rubber (Conductive Flat)	Roller	3.00517.449 COND	6 3/8"	4 1/8"	3 1/2
		350	Perfoma Rubber (Flat/Grey)	Roller	3.00517.449	6 3/8"	4 1/8"	3 1/2
		400	Polyolefin	Roller	3.00517.809	6 3/8"	4 1/8"	3 1/4
			Polyurethane HI-TECH	Roller	3.00517.909	6 3/8"	4 1/8"	3 1/2
			Phenolic	Roller	3.00517.309	6 3/8"	4 1/8"	3 1/4
6"	1 1/2"	300	Perfoma Rubber (Conductive Flat)	Roller	3.00617.449 COND	7 3/8"	4 5/8"	3 3/4
		375	Perfoma Rubber (Flat/Grey)	Roller	3.00617.449	7 3/8"	4 5/8"	3 3/4
		400	Polyolefin	Roller	3.00617.809	7 3/8"	4 5/8"	3
			Polyurethane HI-TECH	Roller	3.00617.909	7 3/8"	4 5/8"	3 3/4
			Phenolic	Roller	3.00617.309	7 3/8"	4 5/8"	3 3/4

### Standard Features

- Zinc plated finish
- Full double ball hardened raceways
- 3/8" hollow axle with lock nut
- Permanent rivet king pin construction
- "Colson 45" multi-temp lube
- .164 steel top plate

### Standard Dimensions

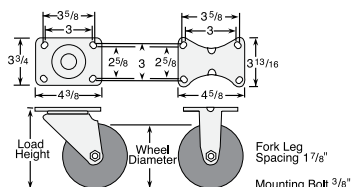

### Options

- Top Lock Brake
- Thread Guards
- Swivel Dust Cap
- NSF Listed

\*Consult factory for additional bearing options.  
 \*\*Rigid model available; change 5th and 6th digits to "08" (Example: 3.00308.449).

# 4 Series

- Top Plate Swivel & Rigid
- Capacity up to 1250 lbs each



### Standard Features

- Zinc plated finish
- 1/2" hollow axle
- 1/4" steel top plate
- Permanent rivet king pin with 5/8" diameter rivet
- Grease fittings: wheel bearing and swivel raceway
- "Colson 45" multi-temp
- Also available in Encore by Colson, consult factory.

### Standard Dimensions

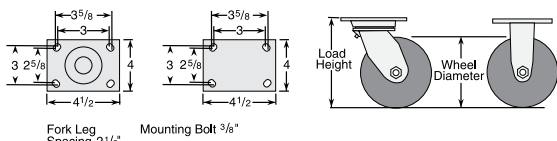

### Options

- Optional Top Plates
- Tread, Tech, Side, Total and Top Lock Brakes
- Foot or Hand Activated Swivel Locks
- DirtBan Swivel Seal
- Thread Guards
- NSF Listed

\*Consult factory for additional bearing options.  
 \*\*Rigid model available; change 6th digit to "8"  
 (Example: 4.04108.492.2).

## Colson 4 Series Casters • Top Plate Swivel & Rigid • Capacity to 1250 lbs

Wheel Dia.	Tread Width	Capacity Each (Pounds)	Wheel Descriptions	Wheel Bearing*	Swivel Top Plate Caster Models**	Load Height	Swivel Radius	Weight lbs (Rigid Deduct 1.5 lbs)
4"	2"	400	Performa Rubber (Flat/Black)	Roller	4.04109.459.2	5 5/8	3 9/16	5 3/4
			Trans-forma LT (Flat)	Roller	4.04109.489	5 5/8	3 9/16	5 3/4
		600	Polyurethane HI-TECH	Roller	4.04109.929	5 5/8	3 9/16	4 3/4
		700	Moldon Polyurethane (Aluminum core)	Roller	4.04109.939	5 5/8	3 9/16	5 1/4
		1000	Moldon Polyurethane (Cast iron core)	Roller	4.04109.949.7	5 5/8	3 9/16	7 1/4
5"	2"	450	Endura Solid Elastomer	Roller	4.04109.839 EN	5 5/8	3 9/16	5 3/4
		500	Trans-forma LT (Flat)	Roller	4.05109.489	6 1/2	4 1/4	6 1/8
		500	Performa Rubber (Flat/Black)	Roller	4.05109.459.2	6 1/2	4 1/4	6 1/8
		650	Polyolefin	Roller	4.05109.839	6 1/2	4 1/4	4 7/8
		750	Polyurethane HI-TECH	Roller	4.05109.929	6 1/2	4 1/4	4 3/4
6"	2"	1000	Endura Solid Elastomer	Roller	4.05109.839 EN	6 1/2	4 1/4	5 3/4
		400	Trans-forma LT (Round)	Roller	4.06109.589	7 1/2	5	6 1/8
		450	Performa Rubber (Round)	Roller	4.06109.559	7 1/2	5	6 1/8
		500	Trans-forma LT (Flat)	Roller	4.06109.489	7 1/2	5	6 1/8
		600	Performa Rubber (Flat/Black)	Roller	4.06109.459.2	7 1/2	5	6 1/8
8"	2"	700	Polyolefin	Roller	4.06109.839	7 1/2	5	5 1/2
		1100	Endura Solid Elastomer	Roller	4.06109.839 EN	7 1/2	5	7
		600	Performa Rubber (Round)	Roller	4.08199.559	9 1/2	6 1/2	6 1/4
		675	Performa Rubber (Flat/Black)	Roller	4.08199.459.2	9 1/2	6 1/2	6 1/4
		900	Polyolefin	Roller	4.08199.839	9 1/2	6 1/2	5 3/4
1000	2"	1000	Polyurethane HI-TECH	Roller	4.08199.929	9 1/2	6 1/2	5 3/4
		1200	Endura Solid Elastomer	Roller	4.08199.839 EN	9 1/2	6 1/2	5 3/4

# 4 Series

- Stainless Steel Top Plate Swivel & Rigid
- Capacity up to 1250 lbs each



### Standard Features

- Polished stainless steel (Grade 304)
- 1/2" stainless steel hollow axle
- 1/4" top plate
- Permanent rivet king pin with 5/8" diameter rivet
- "Colson 45" multi-temp lube

### Standard Dimensions

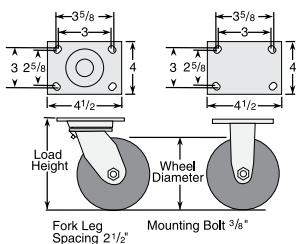

## Colson 4 Series Casters • Stainless Steel Top Plate Swivel & Rigid • Capacity to 1250 lbs

Wheel Dia.	Tread Width	Capacity Each (Pounds)	Wheel Descriptions	Wheel Bearing*	Swivel Top Plate SS Caster Models**	Load Height	Swivel Radius	Weight (Pounds)
4"	2"	400	Performa Rubber (Flat/Black)	Roller	4.04109.459.2 SS	5 5/8	3 9/16	5 3/4
			Trans-forma (Flat)	Roller	4.04109.4E9 SS	5 5/8	3 9/16	5 3/4
		500	Polyolefin	Roller	4.04109.839 SS	5 5/8	3 9/16	4 1/2
		600	Polyurethane HI-TECH	Roller	4.04109.929 SS	5 5/8	3 9/16	4 3/4
		1000	Endura Solid Elastomer	Roller	4.04109.839 EN SS	5 5/8	3 9/16	5 3/4
5"	2"	500	Performa Rubber (Flat/Black)	Roller	4.05109.459.2 SS	6 1/2	4 1/4	6 1/8
			Trans-forma (Flat)	Roller	4.05109.4E9 SS	6 1/2	4 1/4	6 1/8
		650	Polyolefin	Roller	4.05109.839 SS	6 1/2	4 1/4	4 7/8
		750	Polyurethane HI-TECH	Roller	4.05109.929 SS	6 1/2	4 1/4	4 7/8
6"	2"	1000	Endura Solid Elastomer	Roller	4.05109.839 EN SS	6 1/2	4 1/4	5 7/8
		450	Performa Rubber (Round)	Roller	4.06109.559 SS	7 1/2	5	7 1/8
			Trans-forma (Round)	Roller	4.06109.5E9 SS	7 1/2	5	7 1/8
		600	Performa Rubber (Flat/Black)	Roller	4.06109.459.2 SS	7 1/2	5	7 1/8
			Trans-forma (Flat)	Roller	4.06109.4E9 SS	7 1/2	5	7 1/8
8"	2"	700	Polyolefin	Roller	4.06109.839 SS	7 1/2	5	5 1/2
		900	Polyurethane HI-TECH	Roller	4.06109.929 SS	7 1/2	5	5
		1100	Endura Solid Elastomer	Roller	4.06109.839 EN SS	7 1/2	5	6
		600	Performa Rubber (Round)	Roller	4.08199.559 SS	9 1/2	6 1/2	8 1/8
		675	Performa Rubber (Flat/Black)	Roller	4.08199.459.2 SS	9 1/2	6 1/2	8 1/8
1000	2"	900	Polyolefin	Roller	4.08199.839 SS	9 1/2	6 1/2	5 3/4
		1000	Polyurethane HI-TECH	Roller	4.08199.929 SS	9 1/2	6 1/2	5 3/4
		1200	Endura Solid Elastomer	Roller	4.08199.839 EN SS	9 1/2	6 1/2	6 3/4

\*Consult factory for additional bearing options.  
 \*\*Rigid model available; change 6th digit to "8" (Example: 4.04108.459.2 SS).

### Options

- Tech, Side and Top Lock Brakes
- Foot Activated Swivel Lock
- DirtBan Swivel Seal
- Thread Guards
- NSF Listed

# 4 Series

- Kingpinless Top Plate Swivel & Rigid
- Capacity to 1400 lbs



## Colson 4 Series Casters • Enforcer Top Plate Swivel & Rigid • Capacity to 1400 lbs

Wheel Dia.	Tread Width	Capacity Each (Pounds)	Wheel Descriptions	Wheel Bearings*	Swivel Top Plate Caster Models**	Load Height	Swivel Radius	Weight lbs (Rigid Deduct 1.5 lbs)
5"	2"	450	Trans-forma LT (Flat)	Roller	4.05189.4B9	6 1/2"	3 7/8"	6 1/8"
		500	Performa Rubber (Flat/Black)	Roller	4.05189.459.2	6 1/2"	3 7/8"	6 1/8"
		750	Trans-forma HD (Flat/Grey)	Roller	4.05189.4F9	6 1/2"	3 7/8"	6 1/8"
		1000	Polyurethane HI-TECH	Roller	4.05189.929	6 1/2"	3 7/8"	4 3/4"
		1400	Moldon Polyurethane (Cast iron core) Phenolic Forged Steel	Roller Roller Roller	4.05189.949.7 4.05189.339 4.05189.239	6 1/2" 6 1/2" 6 1/2"	3 7/8" 3 7/8" 3 7/8"	7" 5 3/4" 9 1/4"
6"	2"	400	Trans-forma LT (Round)	Roller	4.06189.5B9	7 1/2"	4 5/8"	6 1/8"
		500	Trans-forma LT (Flat)	Roller	4.06189.4B9	7 1/2"	4 5/8"	6 1/8"
		600	Performa Rubber (Flat/Black)	Roller	4.06189.459.2	7 1/2"	4 5/8"	6 1/8"
		650	Trans-forma HD (Round)	Roller	4.06189.5F9	7 1/2"	4 5/8"	6 1/8"
		900	Polyurethane HI-TECH Trans-forma HD (Flat)	Roller Roller	4.06189.929 4.06189.4F9	7 1/2" 7 1/2"	4 5/8" 4 5/8"	5" 6 1/8"
		1100	Endura Solid Elastomer	Roller	4.06189.839 EN	7 1/2"	4 5/8"	7"
		1200	Moldon Polyurethane (Cast iron core) Phenolic	Roller Roller	4.06189.949.7 4.06189.339	7 1/2" 7 1/2"	4 5/8" 4 5/8"	9" 7"
		1400	Forged Steel	Roller	4.06189.239	7 1/2"	4 5/8"	10 1/4"
		8"	2"	675	Performa Rubber (Flat/Black)	Roller	4.08189.459.2	9 1/2"
1000	Polyurethane HI-TECH			Roller	4.08189.929	9 1/2"	6 1/8"	5 3/4"
1200	Endura Solid Elastomer			Roller	4.08189.839 EN	9 1/2"	6 1/8"	8 1/2"
1400	Moldon Polyurethane (Cast iron core) Phenolic			Roller Roller	4.08189.949.7 4.08189.339	9 1/2" 9 1/2"	6 1/8" 6 1/8"	11" 8 1/2"

### Standard Features

- Zinc plated finish
- Single ball hardened raceway
- 1/2" hollow axle
- 5/16" swivel steel top plate for durability, rigid top plate 1/4" steel
- "Colson 45" multi-temp lube
- Also available in Encore by Colson, consult factory.

### Standard Dimensions

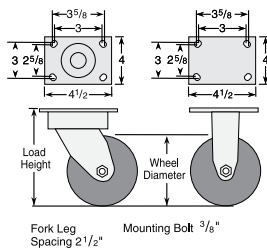

### Options

- Optional Top Plates
- Tread and Side Lock Brakes
- Foot or Hand Activated Swivel Locks
- Optional Extended Lead on 6" & 8"
- Thread Guards
- NSF Listed

\*Consult factory for additional bearing options.  
 \*\*Rigid model available; change 5th and 6th digits to "08" (Example: 4.05108.459.2).  
 For 8" models change 5th and 6th digits only to "98".

# 6 Series

- Kingpinless Top Plate Swivel & Rigid
- Capacity up to 1500 lbs each



## Colson 6 Series Casters • Enforcer Kingpinless Top Plate Swivel & Rigid • Capacity to 1500 lbs

Wheel Dia.	Tread Width	Capacity Each (Pounds)	Wheel Descriptions	Wheel Bearings*	Swivel Top Plate Caster Bearing Models	Load Height	Swivel Radius	Weight lbs (Rigid Deduct 2 lbs)
5"	2"	500	Trans-forma (Flat)	Roller	6.05289.4E9	6 1/2"	3 29/32"	9"
		650	Polyolefin	Roller	6.05289.839	6 1/2"	3 29/32"	9"
		750	Polyurethane HI-TECH Trans-forma HD (Flat)	Roller Roller	6.05289.929 6.05289.4F9	6 1/2" 6 1/2"	3 29/32" 3 29/32"	8 1/2" 9"
		1000	Endura Solid Elastomer Cast Iron	Roller Roller	6.05289.839 EN 6.05289.139	6 1/2" 6 1/2"	3 29/32" 3 29/32"	8" 10 3/4"
		1500	Forged Steel	Roller	6.05289.239	6 1/2"	3 29/32"	11 1/4"
6"	2"	450	Performa Rubber (Round) Trans-forma (Round)	Roller Roller	6.06289.559 6.06289.5E9	7 1/2" 7 1/2"	4 11/16"	7 3/4" 7 3/4"
		600	Performa Rubber (Flat/Black) Trans-forma (Flat)	Roller Roller	6.06289.459.2 6.06289.4E9	7 1/2" 7 1/2"	4 11/16"	7 3/4" 7 3/4"
		650	Trans-forma HD (Round)	Roller	6.06289.5F9	7 1/2"	4 11/16"	10"
		700	Polyolefin	Roller	6.06289.839	7 1/2"	4 11/16"	10"
		900	Polyurethane HI-TECH Trans-forma HD (Flat)	Roller Roller	6.06289.929 6.06289.4F9	7 1/2" 7 1/2"	4 11/16" 4 11/16"	9" 7 3/4"
		1100	Endura Solid Elastomer	Roller	6.06289.839 EN	7 1/2"	4 11/16"	9 1/4"
		1200	Moldon Polyurethane (Cast iron core)	Roller	6.06289.949.7	7 1/2"	4 11/16"	12 1/2"
		1500	Cast Iron	Roller	6.06289.139	7 1/2"	4 11/16"	12 1/2"
		8"	2"	600	Performa Rubber (Round)	Roller	6.08289.559	10 1/8"
675	Performa Rubber (Flat/Black)			Roller	6.08289.459.2	10 1/8"	6 1/2"	8 1/2"
900	Polyolefin			Roller	6.08289.839	10 1/8"	6 1/2"	10 1/4"
1000	Polyurethane HI-TECH			Roller	6.08289.929	10 1/8"	6 1/2"	9 1/2"
1200	Endura Solid Elastomer			Roller	6.08289.839 EN	10 1/8"	6 1/2"	11 1/2"
1500	Moldon Polyurethane (Cast iron core) Cast Iron			Roller Roller	6.08289.949.7 6.08289.139	10 1/8" 10 1/8"	6 1/2" 6 1/2"	16 1/4" 16 1/4"

### Standard Features

- Zinc plated finish
- 1/4" fork leg thickness
- Single ball hardened swivel raceway
- 1/2" hollow axle
- 5/16" steel top plate for durability (1/4" rigid top plate)
- Multi-temp lube

### Standard Dimensions

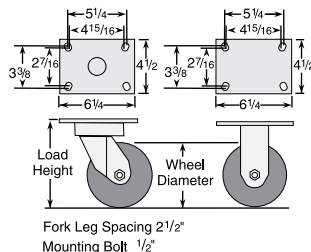

### Options

- Optional Top Plates
- Optional Load Heights, Consult Factory
- Tread and Side Lock Brakes
- Hand Activated Swivel Lock
- Thread Guards

\*Consult factory for additional bearing options.  
 \*\*Rigid model available; change 5th and 6th digits to "08" (Example: 6.05208.839). For 8" models change 5th and 6th digits to "78".

# 7 Series

- Kinpinless Top Plate Swivel & Rigid
- Capacity up to 6000 lbs each



### Standard Features

- Zinc plated finish
- 5/16" steel top plate
- Single ball hardened swivel raceway
- Fork legs 3/8" thick x 2 1/2" wide
- 3/4" solid axle with nut
- Multi-temp lube

### Standard Dimensions

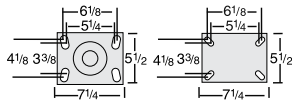

Fork Leg Spacing 3 1/2"

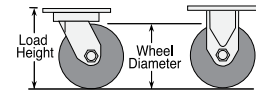

Mounting Bolt 1/2"

## Colson 7 Series Casters • Enforcer Kinpinless Top Plate Swivel & Rigid • Capacity to 6000 lbs

Wheel Dia.	Tread Width	Capacity Each (Pounds)	Wheel Descriptions	Wheel Bearing*	Swivel Top Plate Caster Models**	Load Height	Swivel Radius	Weight lbs (Rigid Deduct 5 lbs)
8"	2 1/2"	2000	Phenolic	7.08689.369	Roller	10 1/8	6 9/16	15 1/2
		840	Moldon Rubber (Cast Iron Core)	7.08689.679.7	Roller	10 1/8	6 9/16	24 3/4
	3"	2500	Phenolic	7.08689.379	Roller	10 1/8	6 9/16	16 1/2
			Moldon Polyurethane (Cast Iron Core)	7.08689.979.7	Roller	10 1/8	6 9/16	27 3/4
		4500	Cast Iron	7.08689.179	Roller	10 1/8	6 9/16	27 3/4
			V-Groove	7.08689.779	Roller	10 1/8	6 9/16	31 1/4
10"	2 1/2"	1000	Performa Rubber (Flat/Black)	7.10689.459.2	Roller	11 1/2	7 5/8	18 1/4
		1200	Polyurethane HI-TECH	7.10689.959	Roller	11 1/2	7 5/8	18 1/4
		2500	Phenolic	7.10689.369	Roller	11 1/2	7 5/8	19 1/2
	3"	1000	Moldon Rubber (Cast Iron Core)	7.10689.679.7	Roller	11 1/2	7 5/8	25 1/4
		2900	Phenolic	7.10689.379	Roller	11 1/2	7 5/8	19 1/2
		3000	Moldon Polyurethane (Cast Iron Core)	7.10689.979.7	Roller	11 1/2	7 5/8	31 1/2
			Cast Iron	7.10689.179	Roller	11 1/2	7 5/8	31 1/2
		4500	Forged Steel	7.10689.279	Roller	11 1/2	7 5/8	37 1/2
12"	3"	1140	Moldon Rubber (Cast Iron Core)	7.12689.679.7	Roller	13 1/2	9 1/8	28 3/4
		1700	Performa Rubber (Flat/Black)	7.12689.459.2	Roller	13 1/2	9 1/8	22 1/4
			Polyurethane HI-TECH	7.12689.989	Roller	13 1/2	9 1/8	22 1/4
		3000	Cast Iron	7.12689.179	Roller	13 1/2	9 1/8	35 3/4
		3500	Phenolic	7.12689.379	Roller	13 1/2	9 1/8	24 3/4
		Moldon Polyurethane (Cast Iron Core)	7.12689.979.7	Roller	13 1/2	9 1/8	40	

\*Consult factory for additional bearing options.  
 \*\*Rigid model available; change 6th digit to "8" (Example: 7.08688.379).

### Options

- Optional Top Plates
- Tread Lock Brake
- Hand Activated Swivel Lock
- Optional Load Heights
- NSF Listed

# 8 Series

- Kinpinless Top Plate Swivel & Rigid
- Capacity up to 6000 lbs each



### Standard Features

- Zinc plated finish
- 3/8" steel top plate
- Single ball hardened swivel raceway
- Fork legs 3/8" thick x 3" wide
- 3/4" solid axle with nut
- Multi-temp lube

### Standard Dimensions

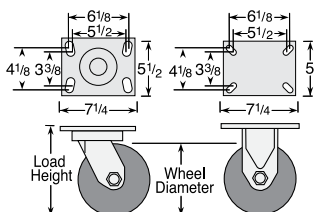

Mounting Bolt 1/2" Fork Leg Spacing for 2 1/2" and 3" tread width: 3 1/2"

## Colson 8 Series Casters • Enforcer Kinpinless Top Plate Swivel & Rigid • Capacity to 6000 lbs

Wheel Dia.	Tread Width	Capacity Each (Pounds)	Wheel Descriptions	Wheel Bearing*	Swivel Top Plate Caster Models**	Load Height	Swivel Radius	Weight lbs (Rigid Deduct 5 lbs)
8"	2 1/2"	2000	Phenolic	Roller	8.08689.369	10 1/8	6 3/16	15 1/2
		840	Moldon Rubber (Cast Iron Core)	Roller	8.08689.679.7	10 1/8	6 3/16	24 3/4
	3"	2500	Phenolic	Roller	8.08689.379	10 1/8	6 3/16	16 1/2
			Moldon Polyurethane (Cast Iron Core)	Roller	8.08689.979.7	10 1/8	6 3/16	27 3/4
		4500	Cast Iron	Roller	8.08689.179	10 1/8	6 3/16	27 3/4
			V-Groove	Roller	8.08689.779	10 1/8	6 3/16	31 1/4
10"	2 1/2"	1000	Performa Rubber (Flat/Black)	Roller	8.10689.459.2	11 1/2	7 3/8	18 1/4
		1200	Polyurethane HI-TECH	Roller	8.10689.959	11 1/2	7 3/8	18 1/4
		2500	Phenolic	Roller	8.10689.369	11 1/2	7 3/8	19 1/2
	3"	1000	Moldon Rubber (Cast Iron Core)	Roller	8.10689.679.7	11 1/2	7 3/8	25 1/4
		2900	Phenolic	Roller	8.10689.379	11 1/2	7 3/8	19 1/2
		3000	Moldon Polyurethane (Cast Iron Core)	Roller	8.10689.979.7	11 1/2	7 3/8	31 1/2
			Cast Iron	Roller	8.10689.179	11 1/2	7 3/8	31 1/2
		4500	Forged Steel	Roller	8.10689.279	11 1/2	7 3/8	37 1/2
12"	3"	1140	Moldon Rubber (Cast Iron Core)	Roller	8.12689.679.7	13 1/2	8 7/8	28 3/4
		1700	Performa Rubber (Flat/Black)	Roller	8.12689.459.2	13 1/2	8 7/8	22 1/4
			Polyurethane HI-TECH	Roller	8.12689.989	13 1/2	8 7/8	22 1/4
		3000	Cast Iron	Roller	8.12689.179	13 1/2	8 7/8	35 3/4
		3500	Phenolic	Roller	8.12689.379	13 1/2	8 7/8	24 3/4
		Moldon Polyurethane (Cast Iron Core)	Roller	8.12689.979.7	13 1/2	8 7/8	40	

\*Consult factory for additional bearing options.  
 \*\*Rigid model available; change 6th digit to "8" (Example: 8.08688.369).

### Options

- Optional Top Plates
- Tread Lock Brake
- Hand Activated Swivel Lock
- Optional Load Heights

# Wheel Selection



## Performa® 1-2 Series

Unique non-marking thermoplastic elastomer tread bonded to polyolefin wheel core.

### Performa® Rubber Wheels • Flat or Round Tread

#### Flat Tread Models

Wheel Dia.	Tread Width	Capacity Each (Pounds)	Bearing	Wheel Model Number
3"	7/8"	125	Delrin	1.00003.441
3 1/2"	1 1/4"	250	Delrin	2.00003.441
			Roller	2.00003.445
4"	7/8"	135	Delrin	1.00004.441
	1 1/4"	300	Delrin	2.00004.441
			Ball	2.00004.445
5"	7/8"	145	Delrin	1.00005.441
	1 1/4"	325	Delrin	2.00005.441
			Ball	2.00005.445

#### Round Tread Models

3 1/2"	1 5/16"	210	Delrin	2.00003.561
			Ball	2.00003.565
5"	1 5/16"	250	Delrin	2.00005.561
			Ball	2.00005.565



## Performa® 5 Series

Non-marking industrial strength thermoplastic elastomer tread bonded to ribbed polyolefin wheel core.

### Performa® Rubber Wheels • Flat Black Tread

Wheel Dia.	Tread Width	Capacity Each (Pounds)	Bearing	Wheel Model Number
4"	2"	400	PPBB	5.00004.455.2
			Delrin	5.00004.451.2
			Roller	5.00004.459.2
5"	2"	500	PPBB	5.00005.455.2
			Delrin	5.00005.451.2
			Roller	5.00005.459.2
6"	2"	500	PPBB	5.00006.455.2
		600	Delrin	5.00006.451.2
			Roller	5.00006.459.2
8"	2"	500	PPBB	5.00008.455.2
		675	Delrin	5.00008.451.2
			Roller	5.00008.459.2

7 Series & Conductive available, consult factory.



Flat grey tread wheels also available in 3-5 Series models.



Round grey tread wheels also available in 5 Series models.



## Trans-forma® LT 5 Series

Lighter duty with TPE tread chemically bonded to polyolefin waffle core.

### Trans-forma® LT Wheels • Flat or Round Tread

#### Flat Tread Models

Wheel Dia.	Tread Width	Capacity Each (Pounds)	Bearing	Wheel Model Number
4"	2"	400	Delrin	5.00004.4B1
			PPBB	5.00004.4B5
			Roller	5.00004.4B9
5"	2"	450	Delrin	5.00005.4B1
			PPBB	5.00005.4B5
			Roller	5.00005.4B9
6"	2"	500	Delrin	5.00006.4B1
			PPBB	5.00006.4B5
			Roller	5.00006.4B9

#### Round Tread Models

6"	2"	400	Delrin	5.00006.5B1
			PPBB	5.00006.5B5
			Roller	5.00006.5B9



## Trans-forma® 5 Series

Multi-purpose and non-marking TPE tread chemically bonded to polyolefin wheel core.

### Trans-forma® Wheels • Flat or Round Tread

#### Flat Tread Models

Wheel Dia.	Tread Width	Capacity Each (Pounds)	Bearing	Wheel Model Number
4"	2"	400	Delrin	5.00004.4E1
			PPBB	5.00004.4E5
			Roller	5.00004.4E9
5"	2"	500	Delrin	5.00005.4E1
			PPBB	5.00005.4E5
			Roller	5.00005.4E9
6"	2"	600	Delrin	5.00006.4E1
			PPBB	5.00006.4E5
			Roller	5.00006.4E9

#### Round Tread Models

6"	2"	450	Delrin	5.00006.5E1
			PPBB	5.00006.5E5
			Roller	5.00006.5E9



## Trans-forma® HD 5 Series

Heavy duty TPE tread chemically bonded to polyolefin waffle core.

### Trans-forma® HD Wheels • Flat or Round Tread

#### Flat Tread Models

Wheel Dia.	Tread Width	Capacity Each (Pounds)	Bearing	Wheel Model Number
4"	2"	600	Delrin	5.00004.4F1
			PPBB	5.00004.4F5
			Roller	5.00004.4F9
5"	2"	750	PPBB	5.00005.4F1
			Delrin	5.00005.4F5
			Roller	5.00005.4F9
6"	2"	900	PPBB	5.00006.4F1
			Delrin	5.00006.4F5
			Roller	5.00006.4F9

#### Round Tread Models

6"	2"	650	Delrin	5.00006.5F1
			PPBB	5.00006.5F5
			Roller	5.00006.5F9



## Moldon Polyurethane HI-TECH® 5 Series

Polyurethane tread mechanically bonded in, around and through "ribbed" polyolefin core.

### Moldon Polyurethane HI-TECH® Wheels

Wheel Dia.	Tread Width	Capacity Each (Pounds)	Bearing	Wheel Model Number
4"	2"	600	PPBB	5.00004.925
			Delrin	5.00004.921
			Roller	5.00004.929
5"	2"	750	PPBB	5.00005.925
			Delrin	5.00005.921
			Roller	5.00005.929
6"	2"	900	PPBB	5.00006.925
			Delrin	5.00006.921
			Roller	5.00006.929
8"	2"	1000	PPBB	5.00008.925
			Delrin	5.00008.921
			Roller	5.00008.929



1-7 Series models available, consult factory.

# Wheel Selection



## Polyolefin 1-2 Series

Hard tread, solid polyolefin wheels construction resists hard impacts and most chemicals.

Polyolefin Wheels				
Wheel Dia.	Tread Width	Capacity Each (Pounds)	Bearing	Wheel Model Number
3"	7/8"	125	Delrin	1.00003.53
	1 1/4"	200	Delrin	2.00003.52
3 1/2"	1 1/4"	250	Delrin	2.00003.53
			Ball	2.00003.55
4"	7/8"	135	Delrin	1.00004.53
			Delrin	2.00004.53
	1 1/4"	275	Ball	2.00004.55
5"	7/8"	145	Delrin	1.00005.53
			Delrin	2.00005.53
	1 1/4"	300	Ball	2.00005.55



3-5 series models also available, consult factory.



## Endura® Solid Elastomer 5 Series

Ergonomic design with exclusive solid elastomer compound rolls easily under heavy loads.

Endura® Solid Elastomer Wheels				
Wheel Dia.	Tread Width	Capacity Each (Pounds)	Bearing	Wheel Model Number
4"	2"	1000	PPBB	5.00004.835 EN
			Delrin	5.00004.831 EN
			Roller	5.00004.839 EN
5"	2"	1000	Prec. Ball	5.00004.8P5 EN
			PPBB	5.00005.835 EN
			Delrin	5.00005.831 EN
6"	2"	1100	Roller	5.00005.839 EN
			Prec. Ball	5.00005.8P5 EN
			PPBB	5.00006.835 EN
8"	2"	1200	Delrin	5.00006.831 EN
			Roller	5.00006.839 EN
			Prec. Ball	5.00006.8P5 EN



## Phenolic 5 Series

Phenolic resin wheel filled with macerated fabric protects floors and resists hard impacts.

Phenolic Wheels				
Wheel Dia.	Tread Width	Capacity Each (Pounds)	Bearing	Wheel Model Number
4"	2"	800	Delrin	5.00004.331
			Roller	5.00004.339
5"	2"	1000	Delrin	5.00005.331
			Roller	5.00005.339
6"	2"	1200	Delrin	5.00006.331
			Roller	5.00006.339
8"	2"	1400	Delrin	5.00008.331
			Roller	5.00008.339



2-8 series models also available, consult factory.



## Steel 5-7 Series

Excellent for excessive load weights when floor protection is not a factor.

Steel Wheels				
Cast Iron Models				
Wheel Dia.	Tread Width	Capacity Each (Pounds)	Bearing*	Wheel Model Number
5"	2"	1000	Roller	5.00005.139
	2 1/2"	2000	Roller	7.00005.169
6"	2"	1500	Roller	5.00006.139
	2 1/2"	2500	Roller	7.00006.169
8"	2"	1500	Roller	5.00008.139
	3"	2500	Roller	7.00008.169

Forged Steel Wheels				
Wheel Dia.	Tread Width	Capacity Each (Pounds)	Bearing*	Wheel Model Number
6"	2"	1700	Roller	5.00006.239
	2 1/2"	4000	Roller	7.00006.269
8"	3"	4500	Roller	7.00008.279

\*For Delrin bearing, change 9th digit to "1" (Example: 5.00005.131).



6 & 8 series models also available, consult factory.



## Thermo® 2-5 Series

Molded from an exclusive engineered resin compound and designed to withstand -70°F to +525°F.

Thermo® Wheels				
Wheel Dia.	Tread Width	Capacity Each (Pounds)	Bearing*	Wheel Model Number
3 1/2"	1 1/4"	300	Plain	2.00003.52 HT
			Plain	2.00004.52 HT
4"	1 1/2"	700	Plain	4.00004.812 HT
			Roller	4.00004.819 HT
	2"	800	Plain	5.00004.832 HT
			Roller	5.00004.839 HT
5"	1 1/4"	325	Plain	2.00005.52 HT
			Roller	4.00005.812 HT
	1 1/2"	800	Plain	4.00005.819 HT
			Roller	4.00005.819 HT
2"	1000	Plain	5.00005.832 HT	
		Roller	5.00005.839 HT	
6"	2"	1100	Plain	5.00006.832 HT
			Roller	5.00006.839 HT

\*Available less bearing, consult factory.



## Moldon Polyurethane Cast Iron Core 5-7 Series

Ultra-durable maroon polyurethane tread bonded to cast iron core with very high strength-to-weight ratio.

Moldon Polyurethane Cast Iron Core Wheels				
Wheel Dia.	Tread Width	Capacity Each (Pounds)	Bearing*	Wheel Model Number
4"	2"	700	Roller	5.00004.949.7
5"	2"	1000	Roller	5.00005.949.7
6"	2"	1200	Roller	5.00006.949.7
	3"	2040	Roller	7.00006.979.7
8"	2"	1500	Roller	5.00008.949.7
	3"	2500	Roller	7.00008.979.7
10"	3"	3000	Roller	7.00010.979.7
12"	3"	3500	Roller	7.00010.979.7

\*For Delrin bearing, change 9th digit to "1" (Example: 5.00004.941.7).

# **colson**<sup>®</sup>

***www.colsoncaster.com***

3D Models Available at  
***www.colsoncaster.com!***



- Click "build 3D model" from our homepage
- Build a caster to your specifications... Spin it around... Zoom in... Select another wheel... Put a brake on it...
- Then, download and import the model directly into your design system

## **Colson Caster**

3700 Airport Road • Jonesboro, AR 72401

Phone: 800-643-5515

Fax: 800-356-6708

E-mail: [info1@colsoncaster.com](mailto:info1@colsoncaster.com)